

# Aspire 2000

## Service Guide

Service guide files and updates are available on the ACER/CSD web; for more information, please refer to <http://csd.acer.com.tw>

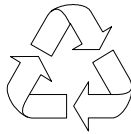

100% Recycled Paper

---

## Revision History

Please refer to the table below for the updates made on Aspire 2000 service guide.

Date	Chapter	Updates

---

## Copyright

Copyright © 2003 by Acer Incorporated. All rights reserved. No part of this publication may be reproduced, transmitted, transcribed, stored in a retrieval system, or translated into any language or computer language, in any form or by any means, electronic, mechanical, magnetic, optical, chemical, manual or otherwise, without the prior written permission of Acer Incorporated.

## Disclaimer

The information in this guide is subject to change without notice.

Acer Incorporated makes no representations or warranties, either expressed or implied, with respect to the contents hereof and specifically disclaims any warranties of merchantability or fitness for any particular purpose. Any Acer Incorporated software described in this manual is sold or licensed "as is". Should the programs prove defective following their purchase, the buyer (and not Acer Incorporated, its distributor, or its dealer) assumes the entire cost of all necessary servicing, repair, and any incidental or consequential damages resulting from any defect in the software.

Acer is a registered trademark of Acer Corporation.

Intel is a registered trademark of Intel Corporation.

Pentium and Pentium II/III are trademarks of Intel Corporation.

Other brand and product names are trademarks and/or registered trademarks of their respective holders.

---

## Conventions

The following conventions are used in this manual:

<b>SCREEN MESSAGES</b>	Denotes actual messages that appear on screen.
<b>NOTE</b>	Gives bits and pieces of additional information related to the current topic.
<b>WARNING</b>	Alerts you to any damage that might result from doing or not doing specific actions.
<b>CAUTION</b>	Gives precautionary measures to avoid possible hardware or software problems.
<b>IMPORTANT</b>	Reminds you to do specific actions relevant to the accomplishment of procedures.

---

## Preface

Before using this information and the product it supports, please read the following general information.

1. This Service Guide provides you with all technical information relating to the BASIC CONFIGURATION decided for Acer's "global" product offering. To better fit local market requirements and enhance product competitiveness, your regional office MAY have decided to extend the functionality of a machine (e.g. add-on card, modem, or extra memory capability). These LOCALIZED FEATURES will NOT be covered in this generic service guide. In such cases, please contact your regional offices or the responsible personnel/channel to provide you with further technical details.
2. Please note WHEN ORDERING FRU PARTS, that you should check the most up-to-date information available on your regional web or channel. If, for whatever reason, a part number change is made, it will not be noted in the printed Service Guide. For ACER-AUTHORIZED SERVICE PROVIDERS, your Acer office may have a DIFFERENT part number code to those given in the FRU list of this printed Service Guide. You MUST use the list provided by your regional Acer office to order FRU parts for repair and service of customer machines.

<b>Chapter 1</b>	<b>System Specifications</b>	<b>1</b>
	Features .....	1
	System Block Diagram .....	3
	Board Layout .....	4
	Top View .....	4
	Rear View .....	5
	Outlook View .....	6
	Open View .....	6
	Front Panel .....	7
	Top Panel .....	8
	Left Panel .....	9
	Right Panel .....	10
	Rear Panel .....	9
	Indicators .....	13
	Keyboard .....	15
	Special keys .....	15
	Embedded Numeric Keypad .....	16
	Windows Keys .....	17
	Hot Keys .....	18
	The Euro Symbol .....	19
	Touchpad .....	19
	Touchpad Basics .....	20
	Launch Keys .....	22
	Hardware Specifications and Configurations .....	23
<b>Chapter 2</b>	<b>System Utilities</b>	<b>37</b>
	BIOS Setup Utility .....	37
	Navigating the BIOS Setup Utility .....	37
	Main .....	40
	Advanced .....	41
	Security .....	44
	Boot .....	46
	Exit .....	47
	BIOS Flash Utility .....	48
	System Diagnostic Diskette .....	48
<b>Chapter 3</b>	<b>Machine Disassembly and Replacement</b>	<b>49</b>
	General Information .....	50
	Before You Begin .....	50
	Disassembly Procedure Flowchart .....	51
	Disassemble the Battery and HDD .....	53
	Disassemble the Wireless .....	53
	Disassemble the RAM and ODD .....	53
	Disassemble the Middle Cover Board .....	54
	Disassemble the Keyboard .....	54
	Disassemble the LCD .....	55
	Disassemble the MDC and RAM .....	55
	Disassemble the Upper Case .....	55
	Disassemble the Main Unit(Touchpad, Bluetooth and LCM Board) .....	55
	Disassemble the Main Unit(Speakers, Fan, Thermal and CPU) .....	56
	Disassemble the Main Unit(VGA, Card Reader, Sub-Woofer and M/B) .....	57
	Disassemble the LCD Module .....	59
	Disassemble the ODD Module .....	60
	Disassemble the HDD Module .....	60

# Table of Contents

<b>Chapter 4</b>	<b>Troubleshooting</b>	<b>61</b>
	System Check Procedures .....	62
	External Diskette Drive Check .....	62
	External CD-ROM Drive Check .....	62
	Keyboard or Auxiliary Input Device Check .....	63
	Memory Check .....	63
	Power System Check .....	63
	Touchpad Check .....	65
	Display Check .....	65
	Sound Check .....	66
	Insyde MobilePro BIOS POST Beep code and POST Messages .....	67
	Index of Symptom-to-FRU Error Message .....	69
	Intermittent Problems .....	73
	Undetermined Problems .....	74
<b>Chapter 5</b>	<b>Jumper and Connector Locations</b>	<b>75</b>
	Top View .....	75
	Bottom View .....	76
<b>Chapter 6</b>	<b>FRU (Field Replaceable Unit) List</b>	<b>77</b>
	Aspire 2000 series .....	77
	Exploded Diagram .....	78
<b>Appendix A</b>	<b>Model Definition and Configuration</b>	<b>88</b>
<b>Appendix B</b>	<b>Test Compatible Components</b>	<b>89</b>
	Microsoft Windows XP (Home) Environment Test .....	90
<b>Appendix C</b>	<b>Online Support Information</b>	<b>92</b>

# System Specifications

---

## Features

This computer was designed with the user in mind. Here are just a few of its many features:

### Performance

- Intel® Pentium M processor at 1.4 ~ 1.7 GHz or higher
- Intel 855PM + Intel ICH4-M
- PC2700 DDR SDRAM, Maximum memory up to 2GB (with two 1024MB SO-DIMM when available)
- Internal slot-in optical drive
- High-capacity, Enhanced-IDE hard disk
- Li-Ion main battery pack
- Power management system with ACPI (Advanced Configuration Power Interface)

### Display

- Thin-Film Transistor (TFT) liquid-crystal display (LCD) displaying 32-bit high true colour up to 16.7 million colours at 1280x800 eXtended Graphics Array (WXGA) resolution
- 3D graphics engine
- Simultaneous LCD and CRT display support
- S-video for output to a television or display device that supports S-video input
- Dual display capability

### Multimedia

- 16-bit high-fidelity AC'97 Codec stereo audio
- Built-in dual speakers with subwoofer
- High-speed optical drive

### Connectivity

- High-speed fax/data modem port
- Ethernet/Fast Ethernet port
- Fast infrared wireless communication
- 3 USB 2.0 (Universal Serial Bus) ports
- IEEE 1394 port
- Intel 802.11b or 802.11a/b wireless LAN (manufacturing optional)
- Bluetooth ready (manufacturing optional)

### Expansion

- One type II CardBus PC Card slot
- Upgradeable memory

### I/O Ports

- One Infrared (FIR)
- One RJ-11 modem jack



- 
- ❑ One RJ-45 network jack
  - ❑ 4-in-1 Card Reader
  - ❑ One DC-in jack for AC adapter
  - ❑ One ECP/EPP-compliant parallel port
  - ❑ One external monitor port
  - ❑ One headphone/speaker/line-out jack (3.5mm mini jack)
  - ❑ One microphone/line-in jack (3.5mm mini jack)
  - ❑ One S-video-out (NTSC/PAL) port
  - ❑ Three Universal Serial Bus (USB) ports
  - ❑ One IEEE 1394 port

# System Block Diagram

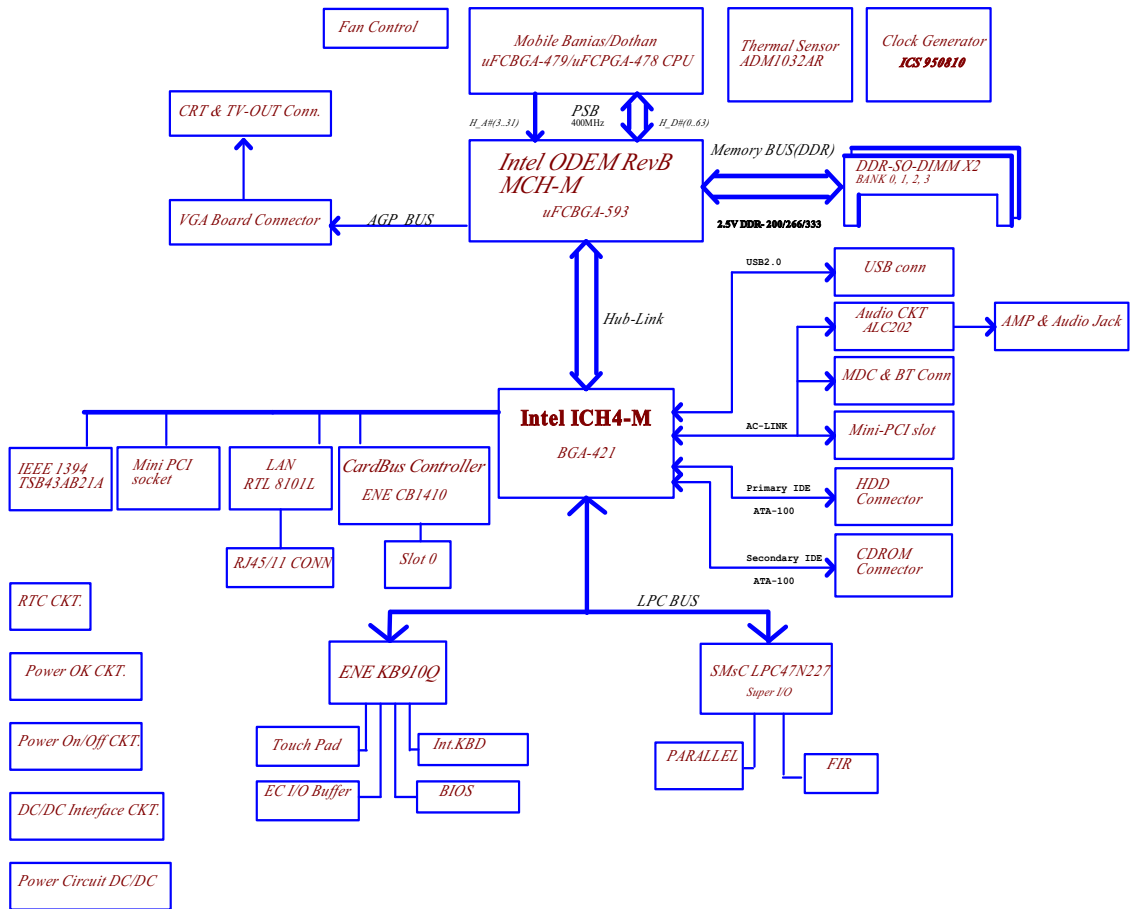

# Board Layout

## Top View

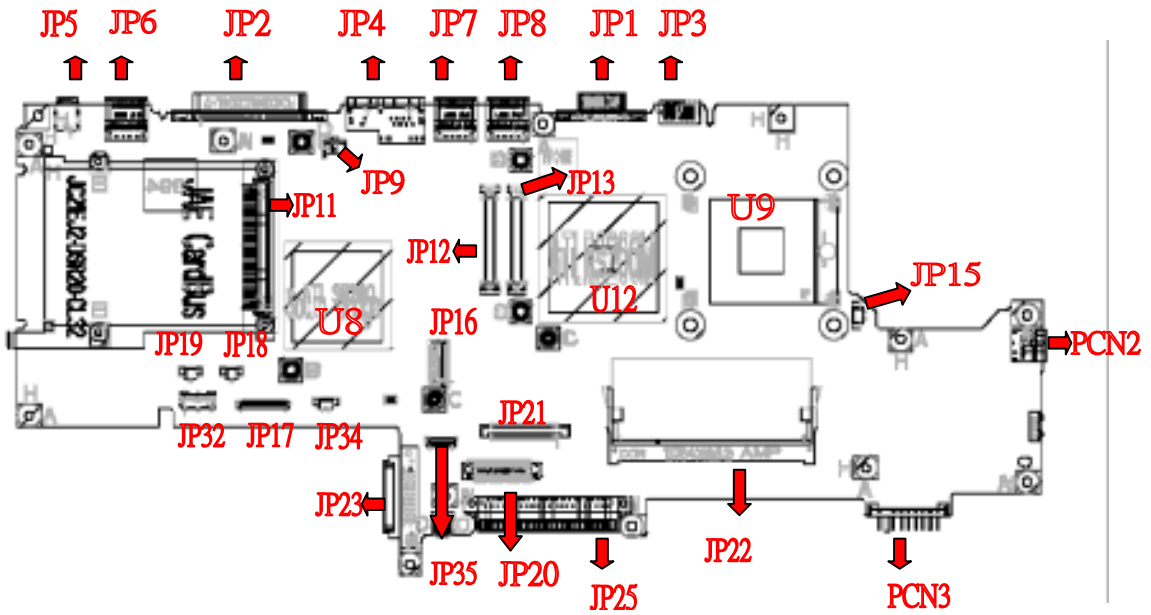

## Rear View

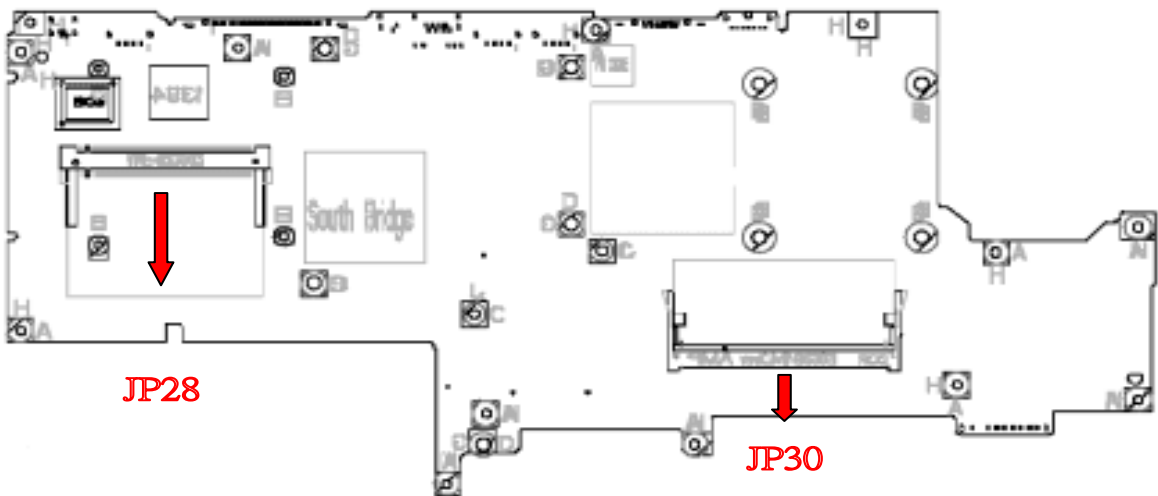

ITEM	DESCRIPTION	ITEM	DESCRIPTION
JP1	CRT	JP19	L-SPK CONN.
JP2	PARALLEL PORT	JP20	T/P CONN.
JP3	TV-OUT CONN.	JP21	KB CONN.
JP4	RJ11/45 CONN.	JP22	SO-DIMM1 CONN.
JP5	1394 CONN.	JP23	CD-ROM CONN.
JP6/7/8	USB CONN.	JP25	HDD CONN.
JP9	MODEM CONN.	JP28	MINI-PCI CONN.
JP11	PCMCIA CONN	JP30	SO-DIMM CONN.
JP12/13	AGP CONN	JP32	CARDREADER CONN.
JP15	FAN CONN.	JP34	SUBWOOFER CONN.
JP16	MDC CONN.	JP35	BLUETOOTH CONN.
JP17	SYSTEM CONN.	JP9	CPU
JP18	R-SPK CONN.	U12	NORTH BRIDGE
		U8	SOUTH BRIDGE

---

# Outlook View

A general introduction of ports allow you to connect peripheral devices, as you would with a desktop PC.

## Open View



#	Item	Description
1	Display	Wide screen display provides visual output.
2	Launch keys	4 buttons that can be programmed to start frequently used applications.
3	Stereo Speakers	Produce stereo sound
4	Touchpad	Touch sensitive pad that functions like a computer mouse.
5	Click buttons & scroll key	Right and left buttons that provide the same functions as the buttons on a computer mouse. The scroll key scrolls the contents of a window up and down.

---

## Front Panel



#	Item	Description
1	Headphone-in Jack	Connects headphones for audio output
2	Microphone-in Jack	Connects an external microphone for audio input
3	4 in 1 Card Reader	Supports MS/MMC/SD/SM kinds of memory sticks
4	Latch	Locks and releases the lid
5	Bluetooth Button	Starts (optional) Bluetooth functionality
6	Wireless Button	Turns an optional internal wireless device on or off

## Top Panel



#	Item	Description
1	Status Indicator	LEDs that turn on and off to show the status of the computers. It's function and components.
2	Arcade	Multimedia button
3	Console Display	Panel control display
4	Stop Button	Stop the Arcade application
5	Media Contrl Button	Multimedia Button

---

## Left Panel

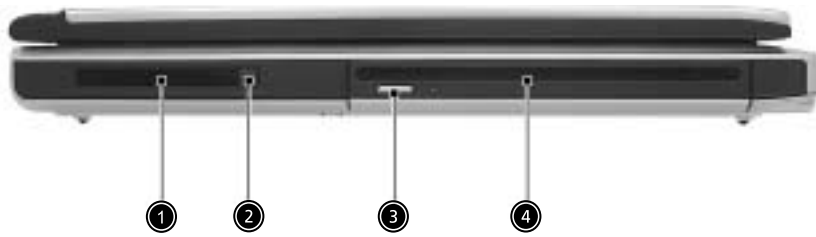

#	Item	Description
1	PC Card Slot	The slot supports a standard Type II PC card (PCMCIA or CardBus).
2	PC card eject button	Press the eject button to remove a PC card from the PC card slot.
3	Eject Button	Ejecting a Disc
4	Slot Loading	Support an optical disc.



---

## Right Panel

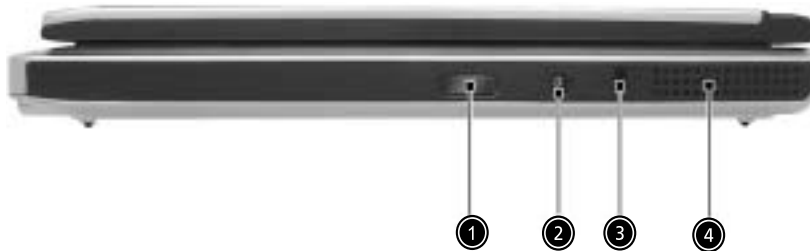

#	Item	Description
1	Infrared Port	Interfaces with infrared devices (e.g., infrared printer, IR-aware computer)
2	DC-in Jack	Connect the AC adapter
3	Kensington lock slot	For attaching a security connector.
4	Ventilation Hole	Enables the computer to stay cool, even after prolonged use.

---

## Rear Panel

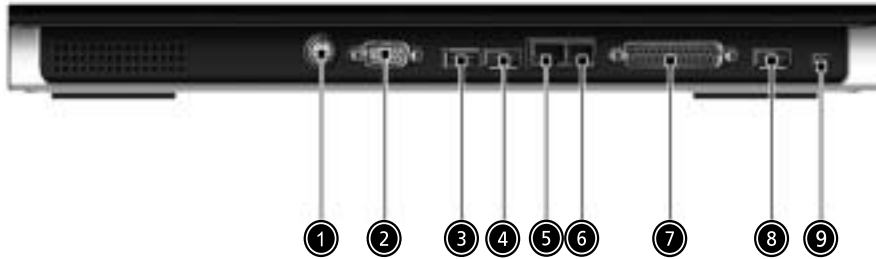

#	Item	Description
1	S-Video	Connects to a television or display device with S-video input.
2	External display port	Connects an external (VGA) display monitor.
3,4,8	USB Ports	Three USB2.0 ports for connecting USB devices.
5	Network Jack	Connects the computer to an Ethernet 10/100-based network.
6	Modem Jack	Connects the built-in fax/data modem to a phone line.
7	Parallel Port	Connects a parallel device, such as a printer.
9	IEEE 1394 Port	Connects IEEE 1394 devices.

## Bottom View

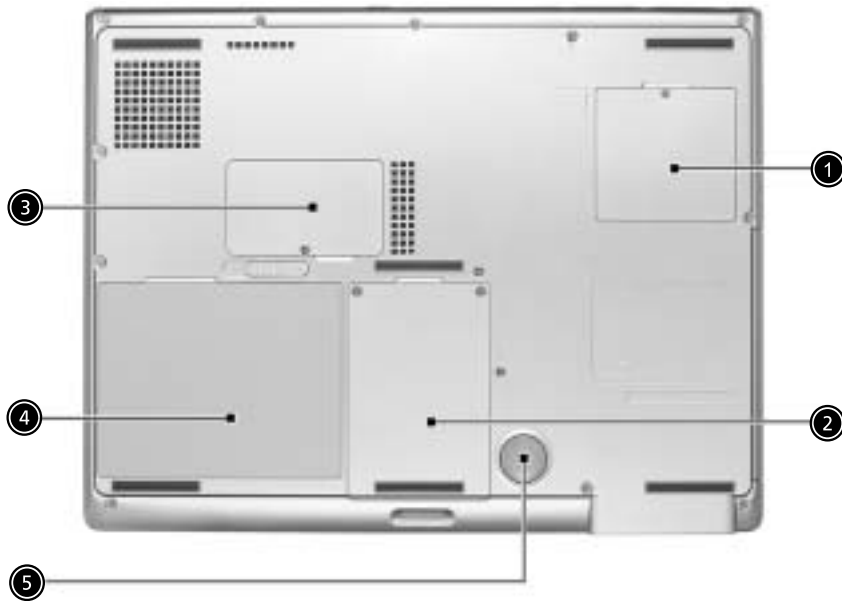

#	Item	Description
1	Mini-PCI Slot	Slot for adding mini-PCI cards
2	Hard disk bay	Removable cover provides access to the computer's hard drive.
3	Memory Compartment	Removable cover provides access to the memory slots for upgrading the computer's memory.
4	Battery Pack	The computer's removable battery.
5	Sub-Woofer	Speaker to output base sound



---

# Indicators

Your computer provides an array of three indicators located above the keyboard, in addition to four indicators positioned at the front of the palm rest area. These indicators show the status of the computer and its components.







The three indicators located above the keyboard provide the following status information:

Icon	Description
	Caps Lock activity
	Num Lock activity
	Scroll Lock activity

**NOTE:** The keypad lock must be turned on to use the embedded numeric keypad.

The four indicators located at the front of the unit provide the following status information:

Icon	Item	Description
	Power mode	<input type="checkbox"/> Steady green --Power on <input type="checkbox"/> Flashing orange --Standby mode <input type="checkbox"/> Orange --Hibernation mode
	Hard Disc mode	<input type="checkbox"/> Lights to Indicate when the hard disc drive is reading or writing data.
	Battery mode	<input type="checkbox"/> Blue -- fully charged <input type="checkbox"/> Flashing orange -- being charged <input type="checkbox"/> Orange -- low on power
	Bluetooth mode	<input type="checkbox"/> Lights to indicate that Bluetooth (optional) is enabled.
	Wireless LAN mode	<input type="checkbox"/> Lights to Indicate status of wireless LAN (optional) communication.

---

# Keyboard

The keyboard features full-size keys with an embedded keypad, separated cursor keys, two Windows keys, and twelve function keys (hot keys).

## Special keys

### Lock keys

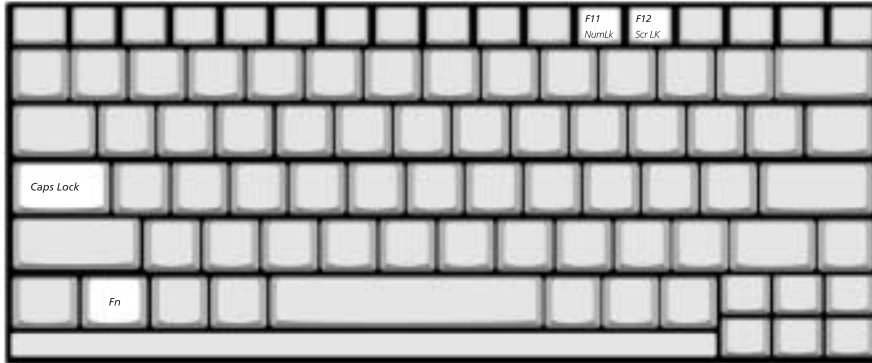

The computer features three lock keys, each with its own status indicator light.

Lock Key	Description
Caps Lock	When Caps Lock is on, all alphabetic characters are typed in uppercase. Toggle on and off by pressing the Caps Lock key on the left side of the keyboard.
Num lock	When Num Lock is on, the embedded numeric keyboard can be used. Toggle on and off by pressing the Fn+t keys simultaneously.
Scroll lock	When Scroll Lock is on, the screen toggles up or down one line at a time when the up and down cursor control keys are pressed.

**NOTE:** Scroll Lock doesn't work in all applications. Toggle on and off by pressing the Fn+F12 keys simultaneously.

---

## Embedded Keypad

The embedded keypad functions like a desktop numeric keypad. It is indicated by small blue numbers and on the applicable keys.

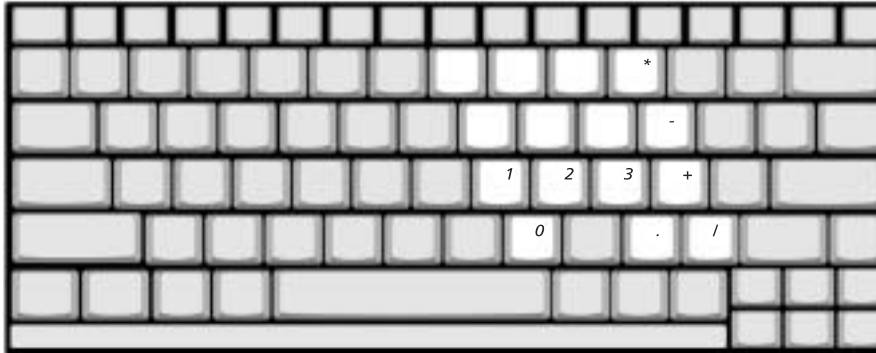

To use the the embedded numeric keys, toggle the Num Lock on by pressing the Fn + F11 keys simultaneously.







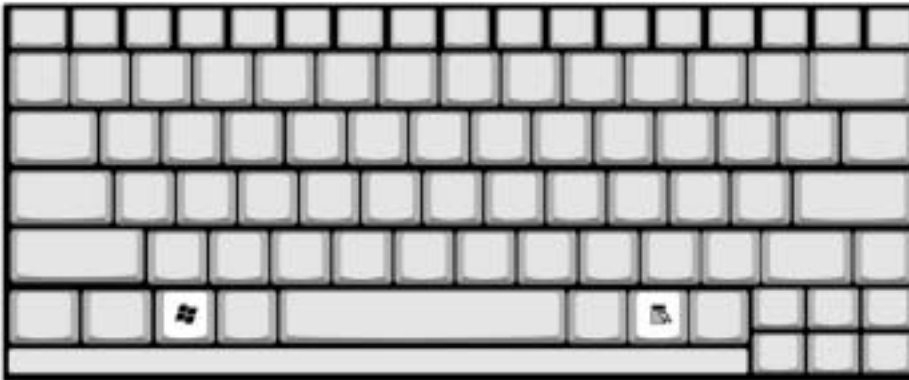

With the embedded keypad turned on, the following actions are possible:

Desired Access	Num Lock On	Num Lock On
Number keys on embedded keypad	Type numbers using embedded keypad in the normal way.	
Cursor-control keys on embedded keypad	Hold down the j key while using the cursor keys on the embedded keypad.	Hold Fn key while using cursor-control keys.
Main keyboard keys	Hold down the Fn key while typing letters using the embedded keypad keys. Simultaneously press the j key for capital letters.	Type letters in the normal way.

## Windows Keys

The keyboard features two keys that perform Windows-specific functions.



Key	Description
Windows logo key 	<p>Pressed alone, this key has the same effect as clicking on the Windows Start button; it launches the Start menu. It can also be used with other keys to provide a variety of functions:</p> <ul style="list-style-type: none"><li> + Tab (Activates the next Taskbar button)</li><li> + E (Opens the My Computer window)</li><li> + F1 (opens Help and Support)</li><li> + F (opens the Find: All Files dialog box)</li><li> + M (minimizes all windows)</li><li>j + Windows logo key + M (undoes the minimize all windows action)</li><li> + R (opens the Run dialog box)</li></ul>
Application key 	<p>This key has the same effect as clicking the right mouse button; it opens the application's context menu.</p>



## Hotkeys

Using the Fn key with another key creates a hot key, providing a quick and convenient method for controlling various functions.

To use a hot key, first hold down the Fn key. Next, press the second key in combination. Finally, release both keys.

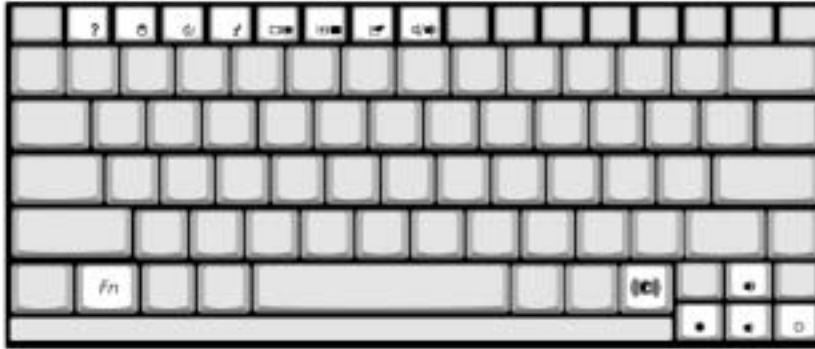

Your computer provides the following hot keys:

Hot Key	Function	Description
Fn+F1	Hot key help	Displays help on hot keys
Fn+F2	Setup	Access the computer's configuration utility.
Fn+F3	Power management scheme toggle	Switches the power management scheme used by the computer (function available if supported by operating system).
Fn+F4	Sleep	Puts the computer in Sleep mode.
Fn+F5	Display toggle	Switches display output between the display screen, external monitor ( if connected) and both the display screen and external monitor.
Fn+F6	Screen blank	Turns the display screen backlight off to save power. Press any key to return.
Fn+F7	Touchpad toggle	Turns the internal touchpad on and off.
Fn+F8	Speaker toggle	Turns the speaker on and off.
Fn+Sub-woofer key	Sub-woofer	Turns the sub woofer on and off
Fn+w	Volume up	Increases the speaker volume.
Fn+y	Volume down	Decreases the speaker volume.
Fn+x	Brightness up	Increases the screen brightness.
Fn+z	Brightness down	Decreases the screen brightness.

**NOTE:** When activating hotkeys, press and hold the **Fn** key before pressing the other key in the hotkey combination.

---

## Euro key

Your computer supports the new Euro currency character. First, hold down the Alt Gr key, and then press the Euro key.

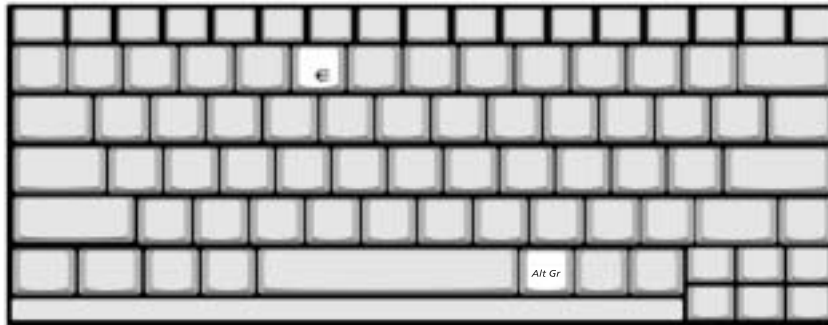

---

# Touchpad

The build-in touchpad is a PS/2 compatible pointing device that senses movement on its surface.

The cursor responds to your finger movements on the touchpad. In addition, the two click buttons provide the same functionality as a computer mouse, while the scroll key enables easy up and down scrolling in documents and web pages.

The touchpad is located in the middle of the palm rest area, providing maximum comfort and efficiency.



## Touchpad Basics

Use the touchpad as follows:



- Slide your finger over the surface of the touchpad to control the movement of the cursor. Tap the touchpad to perform selection and execution functions.
- Press the left (1) and right (3) buttons to perform selection and execution functions, just as you would use the buttons on a computer mouse.
- Use the scroll key (2) to scroll through long documents and web pages. Press the top of the key to scroll up, and the bottom to scroll down; left to scroll left, and right to scroll right.

Function	Left Button	Righ Button	4-Way Scroll Way	Tap
Execute	Click twice quickly			Tap twice (at the same speed as double-clicking the mouse button)
Select	Click once			Tap once

Function	Left Button	Righ Button	4-Way Scroll Way	Tap
Drag	Click and hold. Then slide your finger across the touchpad to drag the cursor over the selection.			Tap twice quickly. On the second tap, slide your finger across the touchpad to drag the cursor over the selection.
Access context menu			Click once	
Scroll			Click and hold the up/down/left/right button	

**NOTE:** Keep your fingers, as well as the surface of the touchpad dry and clean. The touchpad is sensitive to your finger movements: the lighter the touch, the better the response. Tapping hard will not increase the touchpad's responsiveness.

---

# Launch Keys

Located at the top of the keyboard are four buttons, in addition to the power button. These buttons are called launch keys. They are designed as key 1, key 2, key 3 and key 4, from right to left. By default, key 1 is used to launch the email application and key 2 is used to launch the Internet browser. Key 3 and key 4 start the Launch Manager application. The first four launch keys can be set by the user. To set the launch keys, run the Acer Launch Manager.



#	Description
Email	Launches your email application.
Web browser	Launches your Internet browser
P1	User-programmable
P2	User-programmable

---

# Hardware Specifications and Configurations

## Processor

Item	Specification
CPU type	Intel Mobile Pentium M processor at 1.4~1.7 GHz or higher
CPU package	uFCPGA package
CPU core voltage	Support automatic selection of power supply voltage
CPU I/O voltage	1.05V

## BIOS

Item	Specification
BIOS vendor	Insyde
BIOS Version	Insyde MobilePRO BIOS 4.0
BIOS ROM type	Flash ROM
BIOS ROM size	512KB
BIOS package	32 lead of TSSOP
Supported protocols	ACPI 1.0b, PC Card 95, SM BIOS 2.3, EPP/IEEE 1284, ECP/IEEE 1284 1.7 & 1.9, PCI 2.2, PnP 1.0a, DMI 2.0, USB, VGA BIOS, CD-ROM bootable
BIOS password control	Set by setup manual

## Second Level Cache

Item	Specification
Cache controller	Built-in CPU
Cache size	1MB or 2MB
1st level cache control	Always enabled
2nd level cache control	Always enabled
Cache scheme control	Fixed in write-through

## System Memory

Item	Specification
Memory controller	Intel 855PM GMCH
Memory size	128MB/256MB/512MB/1GB
DIMM socket number	2 sockets
Supports memory size per socket	1024MB
Supports maximum memory size	2GB (by two 1024MB SO-DIMM module)
Supports DIMM type	DDR Synchronous DRAM
Supports DIMM Speed	200/266/333MHz
Supports DIMM voltage	2.5V
Supports DIMM package	200-pin SO-DIMM
Memory module combinations	You can install memory modules in any combinations as long as they match the above specifications.

## Memory Combinations

Slot 1	Slot 2	Total Memory
256/512MB	0 MB	256MB/512MB
256/512MB	256MB	512MB/768MB
256/512MB	512MB	768MB/1024MB

**NOTE:** Above table lists some system memory configurations. You may combine DIMMs with various capacities to form other combinations.

## LAN Interface

Item	Specification
Supports LAN protocol	10/100 Mbps
LAN connector type	RJ45
LAN connector location	Rear side

## Modem / Bluetooth Interface

Item	Specification
Data modem data baud rate (bps)	56K
Supports modem/bluetooth protocol	V.90 for MDC / Bluetooth 1.1 standard for BT modem
Modem connector type	RJ11
Modem connector location	Rear side

## Hard Disk Drive Interface

Item	Specification							
Vendor & Model Name	Toshiba 20G MK2023 GAS	Toshiba 30G MK3021 GAS	Toshiba 40G MK4021 GAS	Toshiba 60G MK6021 GAS	Hitachi 20G IC25N02 0-ATMR04	Hitachi 30G IC25N03 0-ATMR04	Hitachi 40G IC25N04 0-ATMR04	Hitachi 60G IC25N06 0-ATMR04
Capacity (MB)	20000	30000	40000	60000	20000	30000	40000	60000
Bytes per sector	512	512	512	512	512	512	512	512
Data heads	2	2	3	4	1	2	2	3
Drive Format								
Disks	1	1	2	2	1	1	1	2
Spindle speed (RPM)	4200 RPM	4200 RPM	4200 RPM	4200/5400 RPM	4200 RPM	4200 RPM	4200 RPM	4200/5400 RPM
Performance Specifications								
Buffer size	2048KB	2048KB	2048KB	2048KB	2048KB	2048KB	2048KB	8192KB
Interface	ATA-5	ATA-5	ATA-5	ATA-5	ATA-5	ATA-5	ATA-5	ATA-5

## Hard Disk Drive Interface

Item	Specification							
Max. media transfer rate (disk-buffer, Mbytes/s)	164.6~257.1	154.3~298.0	154.3~298.0	154.3~298.0	350	350	350	350
Data transfer rate (host~buffer, Mbytes/s)	100 MB/Sec. Ultra DMA mode-5	100 MB/Sec. Ultra DMA mode-5	100 MB/Sec. Ultra DMA mode-5	100 MB/Sec. Ultra DMA mode-5	100 MB/Sec. Ultra DMA mode-5	100 MB/Sec. Ultra DMA mode-5	100 MB/Sec. Ultra DMA mode-5	100 MB/Sec. Ultra DMA mode-5
DC Power Requirements								
Voltage tolerance	5V(DC) +/- 5%	5V(DC) +/- 5%	5V(DC) +/- 5%	5V(DC) +/- 5%	5V(DC) +/- 5%	5V(DC) +/- 5%	5V(DC) +/- 5%	5V(DC) +/- 5%

## Optical Drive Interface

Item	Specification
Vendor & model name	Panasonic UJ-815
Performance Specification	CD-R/RW DVD-ROM
Transfer rate (KB/sec)	(Mode1) 10.3X-24X CAV mode 3600KByte/s (Mode2) 10.3X-24X CAV 1769-4104KByte/s 3.3X-8X CAV 4.3MB/s-10.5 MB/s
Data Buffer Capacity	2 MBytes
Interface	IDE ( ANSI ATA/ATAPI-5)
Applicable disc format	DVD: DVD-ROM (DVD-5, DVD-9, DVD-10), DVD-R (3.95G/4.7G), DVD-RAM (2.6G/4.7G), DVD-RW CD: CD-Audio, CD-ROM(mode 1 and mode 2), CD-ROM XA ( mode2, form 1 and form 2), CD-I ( Ready) CD-I ( Bridge) CD-WO CD-RW Photo CD Video CD Enhanced Music CD CD-TEXT
Loading mechanism	Load: The disc can be loaded semi-automatically ( To load the disc in the drive, it is needed to push the disc manually) Unload: The disc can be unloaded automatically by motor powered mechanism. The disc unloading can be operated by the Eject button or Eject Command through the IDE interface.
Power Requirement	
Input Voltage	+5 V +/- 5 %

## Audio Interface

Item	Specification
Audio Controller	Realtek ALC202A, AC97 Codec



## Audio Interface

Item	Specification
Audio onboard or optional	Built-in
Mono or Stereo	Stereo
Resolution	20 bit stereo Digital to analog converter 18 bit stereo Analog to Digital converter
Compatibility	Microsoft PC99, AC97 2.2 & WHQL
Mixed sound source	CD
Sampling rate	48 KHz
Internal microphone	No
Internal speaker / Quantity	Yes / 2

## Video Interface

Item	Specification
Video vendor	ATI
Video name	M9+X
Chip voltage	Core/1.5V
Supports ZV (Zoomed Video) port	No

## Video Resolution Mode (for both LCD and CRT)

Resolution	16 bits (High color)	32 bits (True color)
1024*768	Yes	Yes
1400*1050 (SXGA)	Yes	Yes
1600*1200 (UXGA)	Yes	Yes
1280*1024 (Monitor)	Yes	Yes

## Parallel Port

Item	Specification
Parallel port controller	SMSC LPC47N227
Number of parallel port	One
Location	Rear side
Connector type	25-pin D-type connector, in female type
Parallel port function control	Enable/Disable/Auto (BIOS or operating system chooses configuration) by BIOS setup <b>Note:</b> Depending on your operating system, disabling an unused device may help free system resources for other devices.
Supports ECP/EPP/Bi-directional (PS/2 compatible)	Yes (set by BIOS setup) <b>Note:</b> When Mode is selected as EPP mode, "3BCh" will not be available.
Optional ECP DMA channel (in BIOS setup)	DMA channel 1
Optional parallel port I/O address (in BIOS setup)	378h, 278h
Optional parallel port IRQ (in BIOS setup)	IRQ7, IRQ5

## USB Port

Item	Specification
USB compliancy level	2.0
OHCI	USB 2.0
Number of USB port	3
Location	Rear side
Serial port function control	Enable/Disable by BIOS setup

## PCMCIA Port

Item	Specification
PCMCIA controller	ENE CB1410 CardBus
Supports card type	Type II
Number of slots	One type-II
Access location	Left panel
Supports ZV (Zoomed Video) port	No ZV support
Supports 32 bit CardBus	Yes

## System Board Major Chips

Item	Controller
System core logic	Intel 855PM and ICH4-M
Super I/O controller	SMSC 47N227, LPC interface
Audio controller	Realtek ALC202A Codec
Video controller	ATI M9+X
Hard disk drive controller	ICH4-M
Keyboard controller	ENE KB910
RTC	ICH4-M

## Keyboard

Item	Specification
Keyboard controller	ENE KB910
Keyboard vendor & model name	Standard keyboard w/o launch button embeded
Total number of keypads	85 keys with 101/102 key emulation
Windows logo key	Yes
Internal & external keyboard work simultaneously	Yes

## Battery

Item	Specification
Vendor & model name	Panasonic/Samsung
Battery Type	Li-ion
Pack capacity	63Wh

## Battery

Item	Specification
Cell voltage	3.7V/cell
Number of battery cell	8
Package configuration	Pin 1: BATT+: Battery positive power pin
	Pin 2: N/A
	Pin 3: B/I: Enable Li-ion battery output, connect to 1k $\Omega$ resistor to GND in system.
	Pin 4: TS: Detector Battery
	Pin 5: EC_SMD1: N/A
	Pin 6: EC_SMC1: SMBus CLOCK
	Pin 7: GND> EC_SMD1=SMBus DATA
Package voltage	Pin8: GND> Battery Ground Power Pin

## LCD Inverter Specification

No.	Supplier	Model	Type
1	CMO	NI54I1-L02	15.4" WXGA
2	LG	LP154W01-A3	15.4" WXGA
3	Samsung	LTN154X1-L02	15.4" WXGA
4	LG	LP154W02-A1	15.4" WSXGA+

There are two control signals that come from system to control lamp brightness. One signal is named DAC\_BRIG, which limits current to meet LCD lamp current specification. Another one is named PWM, which adjusts lamp brightness. This inverter brightness is adjusted by PWM burst mode. The PWM burst mode is that turning on and off the lamp at rate of 150Hz. The effective brightness is a function of the duty cycle.

## Features

1. Wide range 9V to 21V input voltage.
2. Brightness adjustment by PWM duty mode.
3. Close loop controls lamp current.

## Electrical Characteristics

No.	Parameter	Symbol	Min.	Typ.	Max.	Unit	Comment
1	Input voltage	NV_PWR	9	14.8	21	V	7.5V (continuous) can work *Note 1
2	Input current	I <sub>in</sub>	--	0.33	--	A	
3	Lamp current	I <sub>L</sub>	3.0	--	6.8	mA	DAC=0V *Note 2
4	Lamp current	I <sub>L</sub>	2.7	--	6.3	mA	DAC=1V
4	Frequency	F	45	55	65	KHz	* Note 3
5	Output power	P <sub>out</sub>	--	--	4.5	W	
6	Efficiency	η	80%	--	--	--	
7	Starting voltage	V <sub>s</sub>	1600	--	---	V	At 0°C
8	Starting time	T <sub>vs</sub>	1	--	1.5	Sec	
9	Dispo#		2.8	3.3	3.6	V	Backlight on/off signal
			0	0.5	0.8	V	Low level
10	Limited lamp maximum current	DAC-BRIG	0		3.3	V	*Note 2
11	PWM signal *Note 4	INV_PWM	142	150	158	Hz	PWM signal frequency
			3.0	3.3	3.6	V	PWM signal amplitude
			30	--	100	%	Duty = $\frac{T_{on}}{Period}$
12	Lamp current overshoot	I zero-PK	--	--	10	%	Line transient (10.8V to 21V/100us) and turn on transient
13	Current Waveform factor	$\frac{I_p}{I_{rms}}$	1.27	$\sqrt{2}$	1.56	Multiple	$\frac{I_{-p}}{I_{rms}}$ or $I_{rms} * 10$
14	Unbalance Rate	$\frac{I_p -  I_{-p} }{I_{rms}}$	-10%	0	+10%	Multiple	
15	Turn off current (High side)	I <sub>HI</sub>	--	--	0	A	PWM=30%

No	Parameter	Symbol	Min.	Typ.	Max.	Unit	Comment
15	Turn off voltage (Low side)	Voff	--	--	150Vp-p	V	PWM=30%
16	Voltage Rise time (Low side)	Trise	--	--	300us	us	PWM=30%
17	Voltage fall time (Low side)	Tfall	--	--	300us	us	PWM=30%

**NOTE:**

\*1. The inverter can work in 7.5V input voltage (continuous), but 7.5V electronic characteristic will not be care.

\*2. Limited lamp maximum current by DAC\_BRIC signal:

When DAC\_BRIG voltage is 0V and INV\_PWM enables (100%), lamp has max. current.

When DAC\_BRIG voltage is 3.3V and INV\_PWM enables (100%), lamp has min. current.

When add 1V DAC, the 100% Lamp current will decrease 0.5mA.

DAC\_BRIG signal comes from system chipset with internal resistance of 3K  $\Omega$

\*3. Inverter operating frequency should be within specification (45–65kHz) at max. and min. brightness load.

\*4. INV\_PWM enable implies INV\_PWM signal is High level (On duty cycle is 100%). It is a square wave of 150Hz to adjust backlight brightness that is a function of PWM duty cycle. Backlight brightness is maximum value under INV\_PWM at 100% and brightness is minimum under INV\_PWM at 30%.

\*5. The system interface signals belong to 3.3V.

\*6. Please make sure open lamp output voltage should be within starting voltage specification.

\*7. Inverter should pass human body safety test.

\*8. Inverter should be no smoking by any component open/short test.

\*9. Transformer voltage stress should not be over 85% under any condition.

(turn on overshoot transient and line transient.)

\*10. Audio noise should be less than 36dB at 10cm distance.

## Electrical specification

No	Symbol	Min.	Typ.	Max.	Unit	Comment
1	V oper*	--	650	--	Vrms	Lamp operating voltage (650+/-50)
	II	6.2	6.5	6.8	mArms	DAC_BRIG: 0 V, PWM: 100%
	II	3.0	3.3	3.6	mArms	DAC_BRIG: 0 V, PWM:30%
	II	5.7	6.0	6.3	mArms	DAC_BRIG: 0V, PWM:100%
	II	2.7	3.0	3.3	mArms	DAC_BRIG: 1V, PWM:30%
	F	45	55	65	KHz	
	h	80%	--	--	--	

## Thermal

All components on inverter board should follow below rules:

- Component using conditions (component stress) must be within component specification including voltage rating, current rating, temperature etc.
- Component temperature should follow below:
  - $\Delta T \leq 450$  degree C, at 25, 35 degree C.
  - Component temperature should be less than 80 degree C inside system at 35 degree C.

## LCD

Item	Specification			
Vendor & model name	CMO N154I1-L02	Samsung LTN154X1-L02	LG LP154W01-A3	LG LP154W02-A1
Mechanical Specifications				
LCD display area (diagonal, inch)	15.4"	15.4"	15.4"	15.4"
Display technology	TFT	TFT	TFT	TFT
Resolution	WXGA (1280* 800)	WXGA (1280* 800)	WXGA (1280* 800)	WSXGA+ (1650* 1050)
Supports colors	262K	262K	262K	262K
Optical Specification				
Brightness control	keyboard hotkey	keyboard hotkey	keyboard hotkey	keyboard hotkey
Contrast control	No	No	No	No
Suspend/Standby control	Yes	Yes	Yes	Yes
Electrical Specification				
Supply voltage for LCD display (V)	3.3	3.3	3.3	3.3
Supply voltage for LCD backlight (Vrms)	650	690	690	690

## AC Adapter

Item	Specification
Vendor & model name	Delta ADD-65DB Liteon DA-1650-02CR
Input Requirements	
Maximum input current (A, @100Vac, full load)	1.5A max@3.5A/100Vac and 240 Vac
Nominal frequency (Hz)	47 - 63
Frequency variation range (Hz)	47 - 63
Nominal voltages (Vrms)	90 - 264
Inrush current	The maximum inrush current will be less than 50A and 100A when the adapter is connected to 100Vac(60Hz) and 240Vac(50Hz) respectively.
Efficiency	High efficiency 85% minimum, at 100~240Vac AC input, full load, warm-up condition.
Output Ratings (CV mode)	
DC output voltage	Offers constant voltage 19.0V output source with 65W max output power capacity.
Noise + Ripple	300mvp-pmax (20MHz bandwidth) for resistor load
Output current	0 A (min.) 3.5A (max.)
Output Ratings (CC mode)	
DC output voltage	18.0 ~ 20.0
Constant output	3.5A
Dynamic Output Characteristics	
Start-up time	3 sec. (@115 Vac and 230Vac full load)
Hold up time	5ms min. (@115 Vac input, full load)
Over Voltage Protection (OVP)	25V
Short circuit protection	Output can be shorted without damage, and auto recovery
Electrostatic discharge (ESD)	15kV (at air discharge) 8kV (at contact discharge)
Dielectric Withstand Voltage	
Primary to secondary	4242 Vdc for 1 second
Leakage current	60uA at 240Vac/60Hz
Regulatory Requirements	1. FCC class B requirements (USA) 2. VDE class B requirements (German) 3. VCCI classII requirements (Japan)

## Power Management

ACPI Mode	Power Management
Mech. Off (G3)	All devices in the system are turned off completely.
Soft Off (G2/S5)	OS initiated shutdown. All devices in the system are turned off completely.
Working (G0/S0)	Individual devices such as the CPU and hard disk may be power managed in this state.

## Power Management

ACPI Mode	Power Management
Sleeping State (S3)	CPU Power Down VGA Power Down PCMCIA Suspend Audio Power Down Hard Disk Power Down Super I/O Power Down
Sleeping State (S4)	Also called Hibernate state. System saves all system states and data onto the disk prior to power off the whole system.

## Environmental Requirements

Item	Specification
Temperature	
Operating	+5 ~ +35°C
Non-operating	-20 ~ +65°C
Non-operating	-20 ~ +65°C (storage package)
Humidity	
Operating	10% to 90% without condensation
Non-operating	10% to 90% RH, non-condensing (unpacked)
Non-operating	10% to 90% RH, non-condensing (storage package)
Vibration	
Operating (unpacked)	5 ~ 500Hz: 0.9G
Non-operating (unpacked)	5 ~ 500Hz: 1.3G

## Mechanical Specification

Item	Specification
Dimensions	330mm (W) x 273mm (D) x 31.7mm (H) for 14.1/15.0 inch model
Weight	6.11lb (2.77kg) for 14.1 inch model (8 cell battery) 6.41lb (2.9kg) for 15.0 inch model (8 cell battery)
I/O Ports	One type II CardBus slots, One RJ-11 modem jack, One RJ-45 network jack, One DC-in jack for AC adapter, One ECP/EPP-compliant parallel port, One external monitor port, One headphone/speaker/line-out jack (3.5mm mini jack), One microphone/line-in jack (3.5mm mini jack), One S-video-out (NTSC/PAL) port, Three Universal Serial Bus (USB) ports, One IEEE 1394 port.
Drive Bays	One
Material	Recycle plastic PC+ABS 94V0
Indicators	Power, Media activity, Battery charge, Wireless/Bluetooth communication, Caps lock, Pad lock, Num lock and Scroll lock indicators
Switch	Power switch Lid switch User define switch 1, 2 Wireless ON/OFF switch



## Memory Address Map

Memory Address	Size	Function
000E0000h-000FFFFFh	128KB	System BIOS
000C0000h-000CFFFFh	64KB	VGA BIOS
000A0000h-000BFFFFh	128KB	Video memory (VRAM)
00000000h-0009FFFFh	640KB	Conventional memory

## I/O Address Map

I/O Address	Function
0000-001F	Direct memory access controller
0000-0CF7	PCI bus
0010-001F	Motherboard resources
0020-0021	Programmable interrupt controller
0024-0025	Motherboard resources
0028-0029	Motherboard resources
002C-002D	Motherboard resources
002E-002F	Motherboard resources
0030-0031	Motherboard resources
0034-0035	Motherboard resources
0038-0039	Motherboard resources
003C-003D	Motherboard resources
0040-0043	System timer
004C-004F	Motherboard resources
0050-0053	Motherboard resources
0060-0060	Standard 101/102-Key or Microsoft Natural PS/2 Keyboard
0061-0061	System speaker
0062-0062	Microsoft ACPI-Compliant Embedded Controller
0064-0064	Standard 101/102-Key or Microsoft Natural PS/2 Keyboard
0066-0066	Microsoft ACPI-Compliant Embedded Controller
0070-0071	System CMOS/real time clock
0072-0077	Motherboard resources
0080-0080	Motherboard resources
0081-008F	Direct memory access controller
0090-009F	Motherboard resources
00A0-00A1	Programmable interrupt controller
00A4-00A5	Motherboard resources
00A8-00A9	Motherboard resources
00AC-00AD	Motherboard resources
00B0-00B5	Motherboard resources
00B8-00B9	Motherboard resources
00BC-00BD	Motherboard resources
00C0-00DF	Direct memory access controller
00F0-00FE	Numeric data processor
0170-0177	Secondary IDE Channel

## I/O Address Map

I/O Address	Function
01F0-01F7	Primary IDE Channel
0200-020F	Motherboard resources
0274-0277	ISAPNP Read Data Port
0279-0279	ISAPNP Read Data Port
0376-0376	Secondary IDE Channel
0378-037B	ECP Printer Port (LTP1)
03B0-03BB	Intel(R) 82852/82855 GM/GME Graphics Controller
03C0-03DF	Intel(R) 82852/82855 GM/GME Graphics Controller
03F6-03F6	Primary IDE Channel
03F8-03FF	SMC IrCC - Fast Infrared Port
04D0-04D1	Motherboard resources
0778-077B	ECP Printer Port (LTP1)
07F8-07FF	SMC IrCC - Fast Infrared Port
0A79-0A79	ISAPNP Read Data Port
0D00-FFFF	PCI bus
1000-107F	Motherboard resources
1100-110F	Intel(R) 82801DBM Ultra ATA Storage Controller - 24CA
1200-121F	Intel(R) 82801DB/DBM USB Universal Host Controller - 24C2
1300-133F	Motherboard resources
1400-141F	Intel(R) 82801DB/DBM SMBus Controller - 24C3
1600-161F	Intel(R) 82801DB/DBM USB Universal Host Controller - 24C4
1700-171F	Intel(R) 82801DB/DBM USB Universal Host Controller - 24C7
C000-C0FF	Realtek RTL8139/810x Family Fast Ethernet NIC
C100-C17F	VIA OHCI Compliant IEEE 1394 Host Controller
E000-E007	Intel(R) 82852/82855 GM/GME Graphics Controller
E100-E1FF	Realtek AC'97 Audio
E200-E23F	Realtek AC'97 Audio
E300-E3FF	Agere Systems AC'97 Modem
E400-E47F	Agere Systems AC'97 Modem
FD00-FDFF	ENE CB1410 Cardbus Controller
FE00-FE00	Motherboard resources
FF00-FFFF	ENE CB1410 Cardbus Controller

## IRQ Assignment Map

Interrupt Channel	Function(Hardware)
IRQ00	SystemTimer
IRQ01	Standard 101/102-Key or Microsoft Natural PS/2 Keyboard
IRQ04	SMC IrCC - Fast Infrared Port
IRQ08	System CMOS/real time clock
IRQ09	Microsoft ACPI-Compliant System
IRQ12	Alps Pointing-device
IRQ13	Numeric data processor
IRQ14	Primary IDE controller

### IRQ Assignment Map

Interrupt Channel	Function(Hardware)
IRQ15	Secondary IDE controller
IRQ10	Agere Systems AC'97 Modem
	ENE CB1410 Cardbus Controller
	Intel(r) 82801DB/DBM USB 2.0 Enhanced Host Controller - 24CD
	Intel(R) 82801DB/DBM USB Universal Host Controller - 24C2
	Intel(R) 82801DB/DBM USB Universal Host Controller - 24C4
	Intel(R) 82801DB/DBM USB Universal Host Controller - 24C7
	Intel(R) 82852/82855 GM/GME Graphics Controller
	Realtek AC'97 Audio
	Realtek RTL8139/810x Family Fast Ethernet NIC
	VIA OHCI Compliant IEEE 1394 Host Controller

### DMA Channel Assignment

DMA Channel	Function(Hardware)
1	ECP Printer Port (LPT1)
3	SMC IrCC - Fast Infrared Port
4	Direct memory access controller

## System Utilities

### BIOS Setup Utility

The BIOS Setup Utility is a hardware configuration program built into your computer's BIOS (Basic Input/Output System).

Your computer is already properly configured and optimized, and you do not need to run this utility. However, if you encounter configuration problems, you may need to run Setup. Please also refer to Chapter 4 Troubleshooting when problem arises.

To activate the BIOS Utility, press **m** during POST (when "Press <F2> to enter Setup" message is prompted on the bottom of screen).

The setup screen displays BIOS as follows:

Function	Item
Screen	Display system information
Main	Set Date and Time
	Enable/Disable Quiet Boot Logo
	Enable/Disable LCD auto DIM
	Enable/Disable PXE boot from LAN
	Enable/Disable F12 Boot Menu
Advanced	Allow users to set FIR ports
	Allow users to set LPT ports
	Allow users to enable/disable legacy USB
Security	Set User passwords&Set Supervisor passwords
Boot	Allow users to change boot up devices priorities
Exit	Exit and save settings

### Navigating the BIOS Utility

There are five menu options: Main, Advanced, Security, Boot and Exit.

Follow these instructions:

- To choose a menu, use the cursor left/right keys ( z x ).
- To choose a parameter, use the cursor up/down keys ( vwy ).
- To change the value of a parameter, press p or q .
- Press ^ while you are in any of the menu options to go to the Exit menu.
- In any menu, you can load default settings by pressing t . You can also press u to save any changes made and exit the BIOS Setup Utility.

**NOTE:** You can change the value of a parameter if it is enclosed in square brackets. Navigation keys for a particular menu are shown on the bottom of the screen. Help for parameters are found in the Item Specific Help part of the screen. Read this carefully when making changes to parameter values.

Insyde Software SCU		May 20, 2003 5:40:09		
Main	Advanced	Security	Boot	Exit
<p>----Devices-----</p> <p>Product Name = Aspire 2000            Manufacture Name = Acer            System BIOS Version =            VGA BIOS Version =</p> <p>Internal Hard Disk = HITACHI_DK23EA-40-(PM)            HDD Serial Number = 8D4648            DVD/CD-Rom Drive = UJDA740 DVD/CDROM-(SM)</p> <p>Serial Number = ( 32 bytes)            Asset Tag Number = (32 bytes)            UUID = (16 bytes)</p>		<p>----System-----</p> <p>CPU = Intel® Pentium ®            CPU speed = 1400Mhz</p>		
		<p>----Memory-----</p> <p>Base = 640 KB            Extended = 127MB            VGA Memory = 32MB</p>		
<p>Setup system date, time. Enable boot logo and get system information.</p>				

Parameter	Description
Product Name	This field will show product name.
Manufacture Name	This field will show manufacturer name.
BIOS Version	This field reports the BIOS version of system.
VGA Version	This field reports the VGA version of the system.
Internal Hard Disk	This item will show the size of HDD installed on Primary IDE master. The hard disk size is automatically detected by the system. If there is no hard disk present or unknown type, "None" should be shown on this field.
DVD/CD-ROM Drive	This item will show the model name of DVD/CD-ROM drive installed on system. The DVD/CD-ROM model name is automatically detected by the system. If there is no DVD/CD-ROM model present or unknown type, "None" should be shown on this field.
Serial Number	This item will show the Serial number of system.
Asset Tag	This item will show the Asset Tag number of the system.
UUID	This number only valid when there is an internal LAN device presents, otherwise, zero will be display in this field.
System	First field reports the model name of processor. Second field reports CPU Speed.

---

## Memory

Parameter	Description
Base	This field reports the base memory size of system.
Extended	This field reports the extended memory size of the system.
VGA BIOS Version	This field reports the VGA BIOS version of system.

# Main

This menu provides you the information of the system.

Insyde Software SCU		May 20, 2003 5:40:09																						
Main	Advanced	Security	Boot	Exit																				
Date and Time																								
Quiet Boot																								
F12 Boot Menu																								
LCD Auto DIM																								
PXE Boot From LAN																								
		<div style="border: 2px solid cyan; padding: 5px;"> <p style="text-align: center;">-----Date and Time-----</p> <table style="width: 100%; border-collapse: collapse;"> <tr> <td style="width: 20%;">Day</td> <td style="width: 20%; text-align: center;">20</td> <td style="width: 20%;"></td> <td style="width: 20%;">Hour</td> <td style="width: 20%; text-align: center;">8</td> </tr> <tr> <td>Month</td> <td style="text-align: center;">5</td> <td></td> <td>Minute</td> <td style="text-align: center;">35</td> </tr> <tr> <td>Year</td> <td style="text-align: center;">2003</td> <td></td> <td>Second</td> <td style="text-align: center;">9</td> </tr> <tr> <td colspan="2" style="text-align: center;">OK</td> <td colspan="3" style="text-align: center;">Cancel</td> </tr> </table> </div>			Day	20		Hour	8	Month	5		Minute	35	Year	2003		Second	9	OK		Cancel		
Day	20		Hour	8																				
Month	5		Minute	35																				
Year	2003		Second	9																				
OK		Cancel																						
<p>&lt;Tab&gt; &lt;Right&gt; &lt;Left&gt; for block select. &lt;Up&gt; &lt;Down&gt; for item select.            &lt;Enter&gt; for accept. &lt;Cancel&gt; &lt;Esc&gt; for reject. &lt;Alt&gt; activates accelerators.            &lt;Space&gt; for Enable or Disable.</p>																								

Parameter	Description
Date and Time	The hours are displayed with 24 hours format. The values set in these two fields take effect immediately.
Quiet Boot	Customer Logo display will be shown during POST when it is selected.
F12 Boot Menu	When this is selected, users can modify device boot priority by pressing F12 key during POST. When this is not selected, device boot priority will not be adjustable during POST.
LCD Auto DIM	When this is selected, brightness of the LCD will be reduced for power saving when adaptor has been removed from the system. When this is not selected, brightness of the LCD will remain the same after adaptor has been removed from the system.
PXE Boot From LAN	When this is selected, Boot from LAN feature is enabled. When this is not selected, Boot from LAN feature is then disabled.

## Advanced

The Advanced screen contains parameters involving your hardware devices. It also provides advanced settings of the system.

### FIR Ports

Configure the system's infrared port using options: **Disabled** and Enabled.

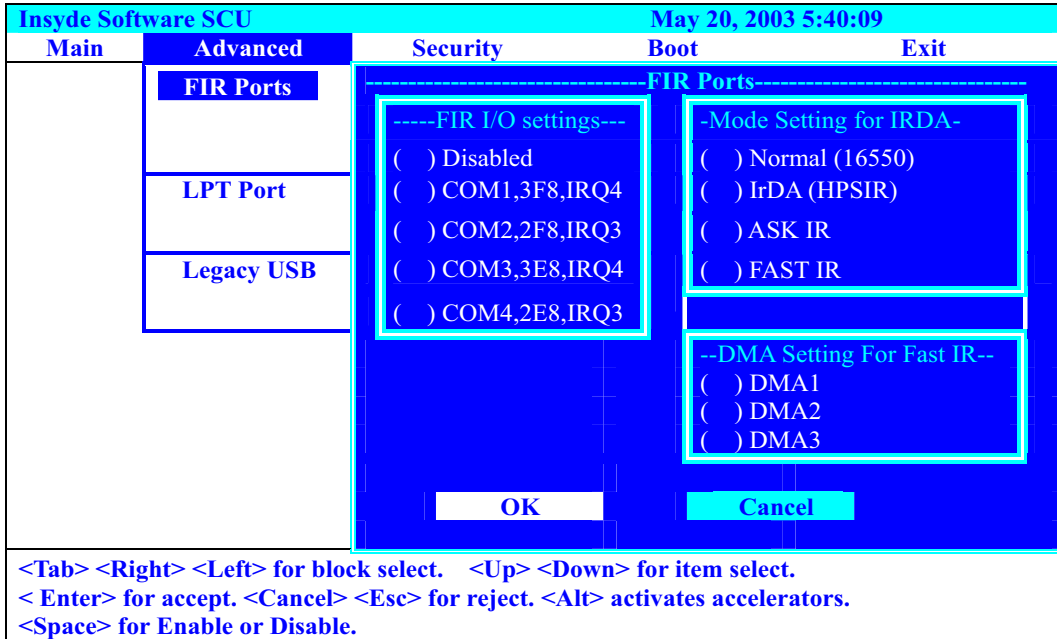

The table below describes the parameters in the screen. Settings in **boldface** are the default and suggested parameter settings.

	Description	Option
FIR I/O Settings	Sets the base I/O address and IRQ for Infrared port.	COM1, 3F8, IRQ4/ COM2, 2F8, IRQ3/ COM3, 3E8, IRQ4/ <b>COM4, 2E8, IRQ3</b>
DMA Setting for Fast IR	Sets a DMA channel for the printer to operate in ECP mode. This parameter is enabled only if Mode is set to ECP.	DMA1, DMA2, <b>DMA3</b> ,
Mode Setting		Normal (16550), IrDA (HPSIR), ASK IR, <b>FAST IR</b>



## LPT Port

Configure the system's parallel port using options: **Disabled** and Enabled.

Insyde Software SCU		May 20, 2003 5:40:09																						
Main	Advanced	Security	Boot	Exit																				
	FIR Ports	<table border="1"> <thead> <tr> <th colspan="2">FIR Ports</th> </tr> </thead> <tbody> <tr> <td>-----Port Address-----</td> <td>-----Port Definition-----</td> </tr> <tr> <td><input type="checkbox"/> None</td> <td><input type="checkbox"/> Standard AT (Centronics)</td> </tr> <tr> <td><input type="checkbox"/> LPT1, 378, IRQ7</td> <td><input type="checkbox"/> Bidirectional (PS-2)</td> </tr> <tr> <td><input type="checkbox"/> LPT2, 278, IRQ5</td> <td><input type="checkbox"/> Enhanced Parallel (EPP)</td> </tr> <tr> <td><input type="checkbox"/> LPT3, 3BC, IRQ7</td> <td><input type="checkbox"/> Extended Capabilities(ECP)</td> </tr> <tr> <td></td> <td>--DMA Setting For Fast IR--</td> </tr> <tr> <td></td> <td><input type="checkbox"/> DMA1</td> </tr> <tr> <td></td> <td><input type="checkbox"/> DMA3</td> </tr> <tr> <td colspan="2" style="text-align: center;"> <input type="button" value="OK"/> <input type="button" value="Cancel"/> </td> </tr> </tbody> </table>			FIR Ports		-----Port Address-----	-----Port Definition-----	<input type="checkbox"/> None	<input type="checkbox"/> Standard AT (Centronics)	<input type="checkbox"/> LPT1, 378, IRQ7	<input type="checkbox"/> Bidirectional (PS-2)	<input type="checkbox"/> LPT2, 278, IRQ5	<input type="checkbox"/> Enhanced Parallel (EPP)	<input type="checkbox"/> LPT3, 3BC, IRQ7	<input type="checkbox"/> Extended Capabilities(ECP)		--DMA Setting For Fast IR--		<input type="checkbox"/> DMA1		<input type="checkbox"/> DMA3	<input type="button" value="OK"/> <input type="button" value="Cancel"/>	
FIR Ports																								
-----Port Address-----	-----Port Definition-----																							
<input type="checkbox"/> None	<input type="checkbox"/> Standard AT (Centronics)																							
<input type="checkbox"/> LPT1, 378, IRQ7	<input type="checkbox"/> Bidirectional (PS-2)																							
<input type="checkbox"/> LPT2, 278, IRQ5	<input type="checkbox"/> Enhanced Parallel (EPP)																							
<input type="checkbox"/> LPT3, 3BC, IRQ7	<input type="checkbox"/> Extended Capabilities(ECP)																							
	--DMA Setting For Fast IR--																							
	<input type="checkbox"/> DMA1																							
	<input type="checkbox"/> DMA3																							
<input type="button" value="OK"/> <input type="button" value="Cancel"/>																								
	LPT Port																							
	Legacy USB																							
<p>&lt;Tab&gt; &lt;Right&gt; &lt;Left&gt; for block select. &lt;Up&gt; &lt;Down&gt; for item select.            &lt;Enter&gt; for accept. &lt;Cancel&gt; &lt;Esc&gt; for reject. &lt;Alt&gt; activates accelerators.            &lt;Space&gt; for Enable or Disable.</p>																								

The table below describes the parameters in the screen. Settings in **boldface** are the default and suggested parameter settings.

	Description	Option
Port Address	Sets the base I/O address for the parallel port. When Mode is selected as EPP mode, "3BC" will not be available.	None/ <b>LPT1, 378, IRQ7</b> / LPT2, 278, IRQ5/ LPT3, 3BC, IRQ7
Port Definition	Sets the mode for the parallel port. Standard AT: Normal mode (AT compatible) Bi-directional: Bi-directional mod (PS/2 compatible) Enhanced Parallel (EPP): EPP mode Extended Compabilities (ECP): ECP mode (requires DMA channel)	Standard AT (Centronics), Bidirectional (PS-2), Enhanced Parallel (EPP), Extended Capabilities(ECP)
DMA Setting for Fast IR	If ECP mode has been selected, then DMA default is DMA1.	<b>DMA1</b> , DAM3

---

## Legacy USB Support

Disabled: Disable support for Legacy Universal Serial Bus.

Enabled: Enable support for Legacy Universal Serial Bus.

Insyde Software SCU		May 20, 2003 5:40:09		
Main	Advanced	Security	Boot	Exit
	FIR Ports			
	LPT Port			
	Legacy USB			
Legacy USB keyboard Floppy Disk USB Mouse Support <Space> for Enable or Disable				

## Security

The Security screen contains parameters that help safeguard and protect your computer from unauthorized use.

Insyde Software SCU		May 20, 2003 5:40:09		
Main	Advanced	Security	Boot	Exit
		Set User Password		
		<b>Set Supervisor Password</b>		
		HDD Drive Lock		
		Password On Boot		

-----Set Supervisor password-----

Enter old Supervisor password: .....

Enter new Supervisor Password: .....

Verify new Supervisor Password: .....

**Enter new password. Password will NOT be displayed**

The table below describes the parameters in this screen. Settings in **boldface** are the default and suggested parameter settings.

### Set Supervisor/User Password

If password on boot is required, the password must be set otherwise it cannot be enabled.

The formats of the password are as follows:

Length      No more than 8 characters

Characters   0-9,A-Z (not case sensitive)

Parameter	Description	Option
Set User Password	Press Enter to set the user password. When set, this password protects the BIOS Setup Utility from unauthorized access.	
Set Supervisor Password	Press Enter to set the administrator password. When set, this password protects the BIOS Setup Utility from unauthorized access.	
HDD Drive Lock	This allows users to protect their Hard Drive being accessed by enabling HDD security to their hard drive.	Disabled/Enabled

---

Parameter	Description	Option
Password on Boot	Defines whether a password is required or not while the events defined in this group happened. The following sub-options are all requires the Supervisor password for changes and should be grayed out if the user password was used to enter setup.  Allows the user to specify whether or not a password is required to boot.	<b>Disabled/Enabled</b>

## Boot

This menu allows the user to decide the order of boot devices to load the operating system. Bootable devices includes the distette drive in module bay, the onboard hard disk drive and the CD-ROM in module bay.

Please select the order of the boot devices

Insyde Software SCU			May 20, 2003 5:40:09	
Main	Advanced	Security	Boot	Exit
			Boot Device	
-----Boot Device-----				
---1 <sup>st</sup> Boot Device---			---2 <sup>nd</sup> Boot Device---	
<input type="checkbox"/> Hard Disk C			<input type="checkbox"/> Hard Disk C	
<input type="checkbox"/> CD-ROM Drive			<input type="checkbox"/> CD-ROM Drive	
<input type="checkbox"/> Diskette A			<input type="checkbox"/> Diskette A	
<input type="checkbox"/> Network Boot			<input type="checkbox"/> Network Boot	
OK			Cancel	
<p>&lt;Tab&gt; &lt;Right&gt; &lt;Left&gt; for block select. &lt;Up&gt; &lt;Down&gt; for item select. &lt;Enter&gt; for accept. &lt;Cancel&gt; &lt;Esc&gt; for reject. &lt;Alt&gt; activates accelerators. &lt;Space&gt; for Enable or Disable.</p>				

## Exit

The Exit screen contains parameters that help safeguard and protect your computer from unauthorized use.

Insyde Software SCU				May 20, 2003 5:40:09	
Main	Advanced	Security	Boot	Exit	
				Exit Saving Changes	
				Exit Discarding Changes	
				Load Setup Default	
				Discard Changes	
<div style="border: 2px solid red; padding: 10px; margin: 10px auto; width: 80%;"> <p style="text-align: center;">-----Exit Saving Changes-----</p> <p style="text-align: center;">Press &lt;OK&gt; to save the current Setup parameters to CMOS RAM.</p> <p style="text-align: center;">The computer will be rebooted!!!</p> <div style="display: flex; justify-content: center; gap: 20px;"> <span style="border: 1px solid black; padding: 5px 15px;">OK</span> <span style="border: 1px solid black; padding: 5px 15px;">Cancel</span> </div> </div>					
<p>&lt;Tab&gt; &lt;Right&gt; &lt;Left&gt; for block select. &lt;Up&gt; &lt;Down&gt; for item select.            &lt;Enter&gt; for accept. &lt;Cancel&gt; &lt;Esc&gt; for reject. &lt;Alt&gt; activates accelerators.            &lt;Space&gt; for Enable or Disable.</p>					

The table below describes the parameters in this screen.

Parameter	Description
Exit Saving Changes	Allows the user to save changes to CMOS and reboot the system.
Exit Discarding Changes	Allows the user Discards changes made and exits System Setup.
Load Setup Default	Loads default settings for all parameters (same as t ).
Discard Changes	Allows the user to discard previous changes in CMOS Setup.

---

## BIOS Flash Utility

The BIOS flash memory update is required for the following conditions:

- New versions of system programs
- New features or options
- Restore a BIOS when it becomes corrupted.

Use the Flash utility to update the system BIOS flash ROM.

**NOTE:** If you do not have a crisis recovery diskette at hand, then you should create a **Crisis Recovery Diskette** before you use the Flash utility.

**NOTE:** Do not install memory-related drivers (XMS, EMS, DPMS) when you use the Flash utilities.

**NOTE:** Please use the AC adaptor power supply when you run the Flash utility. If the battery pack does not contain enough power to finish BIOS flash, you may not boot the system because the BIOS is not completely loaded.

Follow the steps below to run the Flash.

1. Prepare a bootable diskette.
2. Copy the Flash utilities to the bootable diskette.
3. Then boot the system from the bootable diskette. The Flash utility has auto-execution function.

## System Diagnostic Diskette

This diagnostic diskette is for the Acer Aspire 2000 series notebook machine. However, system diagnostic utility is not ready as service CD released. Acer HQ CSD will upload the utility to CSD website as soon as it is ready.

# Machine Disassembly and Replacement

---

This chapter contains step-by-step procedures on how to disassemble the notebook computer for maintenance and troubleshooting.

To disassemble the computer, you need the following tools:

- Wrist grounding strap and conductive mat for preventing electrostatic discharge
- small Philips screwdriver
- flat head screwdriver
- Philips screwdriver
- nut screwdriver
- tweezers

**NOTE:** The screws for the different components vary in size. During the disassembly process, group the screws with the corresponding components to avoid mismatch when putting back the components.

When you remove the stripe cover, please be careful not to scrape the cover.



---

# General Information

## Before You Begin

Before proceeding with the disassembly procedure, make sure that you do the following:

1. Turn off the power to the system and all peripherals.
2. Unplug the AC adapter and all power and signal cables from the system.
3. Remove the battery pack.

# Disassembly Procedure Flowchart

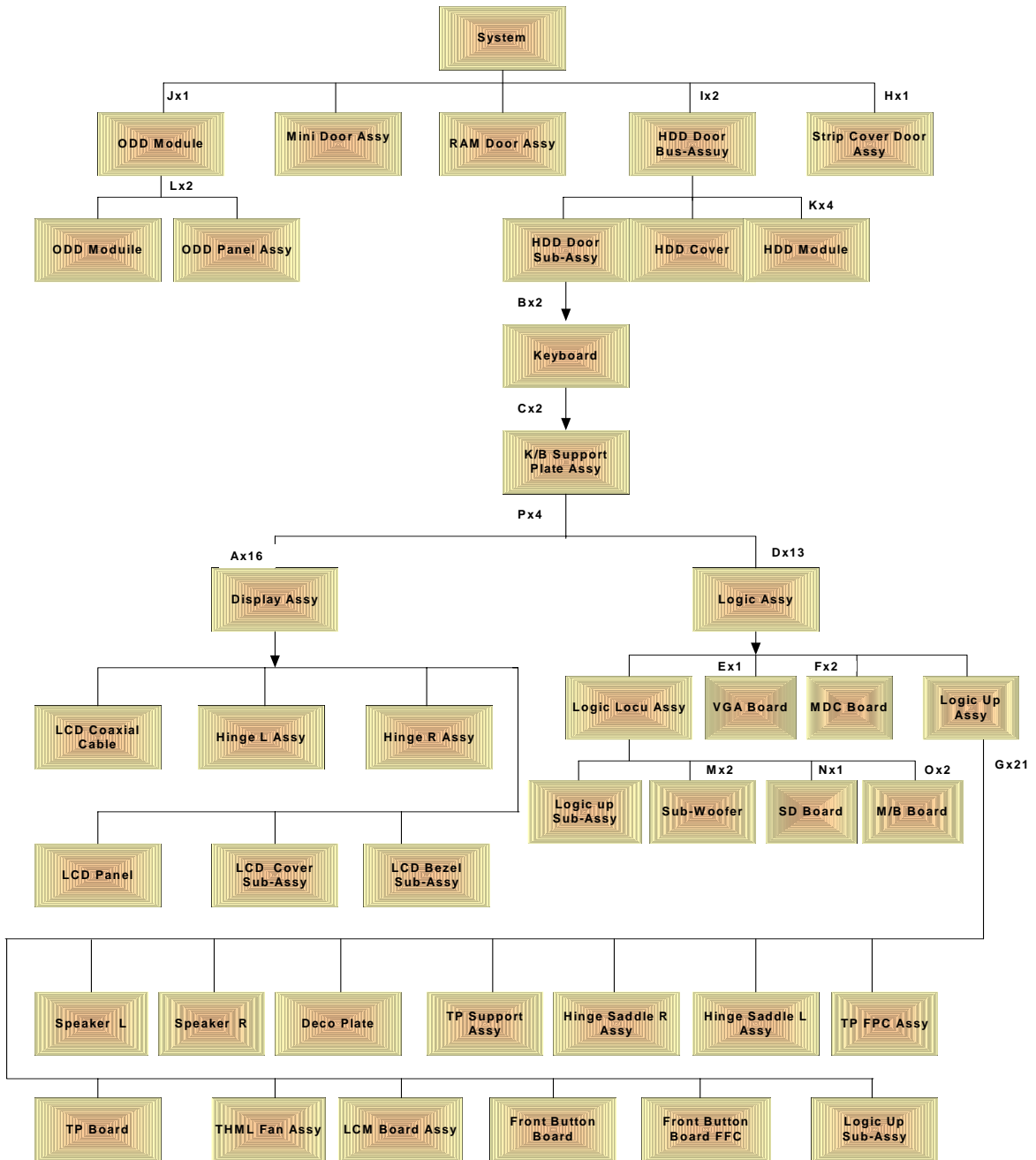

Item	Description
A	M2.5x5 M2.0x4
B	M2.5x3
C	M2.5x4
D	M2.5x10 M2.5x4

---

Item	Description
E	M2.5x14
F	M2.0x4
G	M2.5x4
H	M2.5x14
I	M2.5x10
J	M2.5x5
K	M3.0x3
L	M2.0x3
M	2.5x4
N	M2.5x4
O	M2.5x5
P	M2.5x4

---

## Aspire 2000 Disassembly Procedure

This section will guide you how to disassemble the system when you need to perform system service. Please also refer to the disassembly video, if available.

**CAUTION:** Before you proceed, make sure you have turned off the system and all peripherals connected.

### Disassemble the Battery and HDD

1. Release the battery lock and slide the battery latch.
2. Then remove the battery pack.
3. Remove the two screws to release the hard drive door. Then take it away.



### Disassemble the Wireless

1. Remove the one screw to release the mini door, and take it away.
2. Disconnect the two wireless cables.
3. Then take the wireless board from the base.



### Disassemble the RAM and ODD

1. Remove the one screw to release the RAM door and remove it.
2. Press down the both side latches to release the RAM board.
3. Remove the one screw to release the ODD module.
4. Then push the inner position to remove the ODD from the base.
5. Pull the entire ODD module from the system.





## Disassemble the Middle Cover Board

1. Remove the one screw.
2. Detach the middle cover from the unit with the flat screw driver.
3. Disconnect the system cable from the middle cover board.
4. Remove the two screws to release the middle cover board.
5. Then detach the middle cover board from cover.



## Disassemble the Keyboard

1. Remove the screws on each side.
2. Pull up both sides of the latches to disconnect the FFC from the mainboard.
3. Remove the screws on each side to release the keyboard bracket.
4. Then take the keyboard supporter bracket from the system.



---

## Disassemble the LCD

1. Remove the one screw from the LVDS board.
2. Pull the LCD coaxial board and the cable from the system.
3. Remove the two screws from the hinge on each side to release the LCD panel.
4. Pull the entire LCD module from the system.



## Disassemble the MDC and RAM

1. Remove the two screws to release the MDC board.
2. Disconnect the MDC cable before you take the MDC board.
3. Press down the both sides latches to release the RAM.
4. Disconnect the right and left speaker cables from the mainboard.
5. Disconnect the touchpad FPC connector and CPU fan cable.



## Disassemble the Upper Case

1. Remove the thirteen screws located on the base case.
2. Remove the two screws on the other side to located on the rear panel.
3. Remove the three screws to release the upper case.
4. Detach the upper case from the system.



---

## Disassemble the Main Unit ( Touchpad, Bluetooth and LCM Board)

1. Remove the seven screws to release the touchpad supporter bracket.
2. Disconnect the touchpad FPC connector.
3. Disconnect the cable as highlights.
4. Then detach the touchpad bracket from the position.
5. Detach the touchpad PC from the module.
6. Disconnect the bluetooth board FFC connector.
7. Remove the two screws to release the bluetooth board.
8. Take the bluetooth board from the system.
9. Remove the one screw to release the LCM board.
10. Detach the LCM board from the system.



---

## Disassemble the Main Unit ( Speakers, Fan, Thermal and CPU)

1. Remove the one screw to release the up hinge saddle.
2. Remove the three screws to release the bottom hinge saddle.
3. Detach the right hinge saddle from the case.
4. Remove the two screws to release the right hinge saddle.
5. Take the right speaker from the position.
6. Remove the one screw to release the CPU fan from the hinge saddle.
7. Take the CPU fan from the hinge saddle.

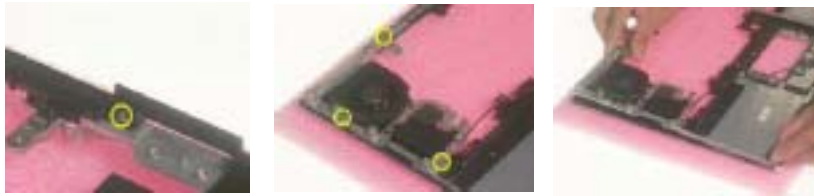

8. Remove the three screws to release the left hinge saddle.
9. Detach the left hinge saddle from the system.
10. Remove the one screw to release the left speaker from the base cover.
11. Then detach the left speaker.
12. Remove the four screws to release the thermal module.
13. Detach the thermal module from the system.
14. Remove the one screw to release the CPU.
15. Detach the CPU fan from the socket.

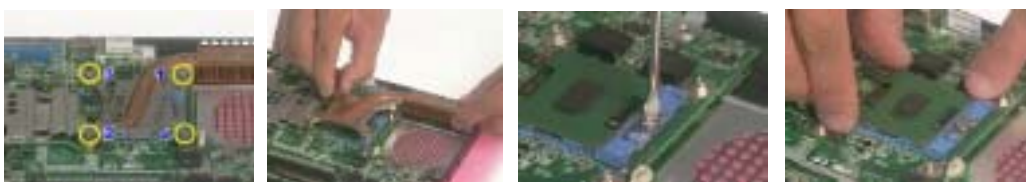



---

## Disassemble the Main Unit ( VGA, Card Reader, Sub-Woofer and Mainboard)

1. Remove the one screw to release the VGA bracket.
2. Detach the VGA module from the mainboard.
3. Separate the VGA bracket and the VGA board.



4. Remove the ground screw to release the card reader.
5. Disconnect the card reader cables on each side.
6. Disconnect the sub-woofer cable
7. Remove the screws on each side to release the sub-woofer.
8. Detach the sub-woofer from the case.
9. Detach the card reader board from the case.



10. Remove the one screw to release the mainboard.
11. Press the PCMCIA button and hold the position to release the mainboard from the case.



---

## Disassemble the LCD Module

1. Remove the screws on each side.
2. Detach the bezel from the LCD panel.
3. Remove the screws located on the different side.
4. Detach the LCD panel from the cover.
5. Take the antenna away from the position to release the inverter board.
6. Disconnect the LCD coaxial cables.
7. Remove the four screws to release the left LCD bracket.
8. Take the left LCD bracket from the panel.
9. Remove the four screws to release the right LCD bracket.
10. Take the right LCD bracket from the panel.



---

## Disassemble the ODD Module

1. Remove the two screws to separate the ODD drive.
2. Detach the ODD bracket.
3. Detach the ODD door.



## Disassemble the HDD Module

1. Remove the two screws on each side.
2. Separate the hard disk top cover and take the hard drive from the carrier.
3. Remove the hard disk connector from the rear position.



## Troubleshooting

---

Use the following procedure as a guide for computer problems.

1. Obtain the failed symptoms in as much detail as possible.
2. Verify the symptoms by attempting to re-create the failure by running the diagnostic test or by repeating the same operation.
3. If any problem occurs, you can perform visual inspection before you follow this chapter's instructions.

You can check the following:

- power cords are properly connected and secured;
- there are no obvious shorts or opens;
- there are no obviously burned or heated components;
- all components appear normal.

4. After you perform visual inspection you can also verify the following:
  - ask the user if a password is registered and, if it is, ask him or her to enter the password.
  - verify with the customer that Windows XP is installed on the hard disk. Operating systems that were not preinstalled by Acer can cause malfunction.
  - make sure all optional equipment is removed from the computer.
  - make sure the floppy disk is empty.
5. Use the following table with the verified symptom to determine which page to go to.

Symptoms (Verified)	Go To
Power failure. (The power indicator does not go on or stay on.)	"Power System Check"
POST does not complete. No beep or error codes are indicated.	"Insyde MobilePro BIOS POST Beep Code and POST Messages" "Undetermined Problems"
POST detects an error and displayed messages on screen.	"Insyde MobilePro BIOS POST Beep Code and POST Messages"
Other symptoms (i.e. LCD display problems or others).	"Insyde MobilePro BIOS POST Beep Code and POST Messages"
Symptoms cannot be re-created (intermittent problems).	Use the customer-reported symptoms and go to "Insyde MobilePro BIOS POST Beep Code and POST Messages" on page 67 "Intermittent Problems" "Undetermined Problems"

---

# System Check Procedures

## External Diskette Drive Check

Do the following steps to isolate the problem to a controller, driver, or diskette. A write-enabled, diagnostic diskette is required.

**NOTE:** Make sure that the diskette does not have more than one label attached to it. Multiple labels can cause damage to the drive or cause the drive to fail.

Do the following to select the test device.

1. The FDD heads can become dirty over time, affecting their performance. Use an FDD cleaning kit to clean the heads. If the FDD still does not function properly after cleaning, go to next step.
2. Boot from diagnostic program.
3. If an error occurs with the internal diskette drive, reconnect the diskette connector on the main board.

If the error still remains:

1. Reconnect the external diskette drive module.
2. Replace the external diskette drive module.
3. Replace the main board.

## External CD-ROM/DVD-ROM Drive Check

Do the following to isolate the problem to a controller, drive, or CD-ROM/DVD-ROM. Make sure that the CD-ROM does not have any label attached to it. The label can cause damage to the drive or can cause the drive to fail.

Do the following to select the test device:

1. Insert an audio CD into the CD/DVD drive. If the CD/DVD drive can read the data from the audio CD. The drive does not have problem, then go to next step. If the CD/DVD LED on the front panel does not emit light as it read the data from the audio CD, then go to next step. However, if the CD/DVD drive can not read data from the audio CD, you may need to clean the CD/DVD drive with a CD/DVD drive cleaning disk.
2. Make sure that the appropriate driver has been installed on the computer for the CD/DVD drive.
3. Boot from the diagnostics diskette and start the diagnostics program
4. See if CD-ROM Test is passed when the program runs to CD-ROM/DVD-ROM Test.
5. Follow the instructions in the message window.

If an error occurs, reconnect the connector on the main board. If the error still remains:

1. Reconnect the CD-ROM/DVD-ROM module.
2. Replace the CD-ROM/DVD-ROM module.
3. Replace the main board.

---

## Keyboard or Auxiliary Input Device Check

Remove the external keyboard if the internal keyboard is to be tested.

If the internal keyboard does not work or an unexpected character appears, make sure that the flexible cable extending from the keyboard is correctly seated in the connector on the main board.

If the keyboard cable connection is correct, run the Keyboard Test.

If the tests detect a keyboard problem, do the following one at a time to correct the problem. Do not replace a non-defective FRU:

1. Reconnect the keyboard cables.
2. Replace the keyboard.
3. Replace the main board.

The following auxiliary input devices are supported by this computer:

- Embedded Numeric Keypad
- External keyboard

If any of these devices do not work, reconnect the cable connector and repeat the failing operation.

## Memory Check

Memory errors might stop system operations, show error messages on the screen, or hang the system. Currently, we do not provide memory test program. However, if you need to check memory but have no testing program or diagnostic utility at hand, please go to <http://www.passmark.com> to download the shareware "BurnIn Test V.3.0". You may test the memory with this program under Window XP environment.

**NOTE:** Make sure that the DIMM is fully installed into the connector. A loose connection can cause an error.

## Power System Check

To verify the symptom of the problem, power on the computer using each of the following power sources:

1. Remove the battery pack.
2. Connect the power adapter and check that power is supplied.
3. Disconnect the power adapter and install the charged battery pack; then check that power is supplied by the battery pack.

If you suspect a power problem, see the appropriate power supply check in the following list:

- "Check the Power Adapter"
- "Check the Battery Pack"

---

## Check the Power Adapter

Unplug the power adapter cable from the computer and measure the output voltage at the plug of the power adapter cable. See the following figure

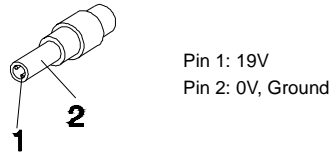

1. If the voltage is not correct, replace the power adapter.
2. If the voltage is within the range, do the following:
  - Replace the main board.
  - If the problem is not corrected, see “Undetermined Problems”.
  - If the voltage is not correct, go to the next step.

**NOTE:** An audible noise from the power adapter does not always indicate a defect.

3. If the DC-IN indicator does not light up, check the power cord of the power adapter for correct continuity and installation.
4. If the operational charge does not work, see “Check the Power Adapter” .

---

## Check the Battery Pack

To check the battery pack, do the following:

From Software:

1. Check out the Power Options in control Panel
2. In Power Meter, confirm that if the parameters shown in the screen for Current Power Source and Total Battery Power Remaining are correct.
3. Repeat the steps 1 and 2, for both battery and adapter.
4. This helps you identify first the problem is on recharging or discharging.

From Hardware:

1. Power off the computer.
2. Remove the battery pack and measure the voltage between battery terminals 1(+) and 6(ground).
3. If the voltage is still less than 7.5 Vdc after recharging, replace the battery.
4. If the voltage is within the normal range, run the diagnostic program.

To check the battery charge operation, use a discharged battery pack or a battery pack that has less than 50% of the total power remaining when installed in the computer.

If the battery status indicator does not light up, remove the battery pack and let it return to room temperature. Re-install the battery pack.

If the charge indicator still does not emit, replace the battery pack. If the charge indicator still does not light up, replace the DC/DC charger board.

## Touchpad Check

If the touchpad doesn't work, do the following actions one at a time to correct the problem. Do not replace a non-defective FRU:

1. After rebooting, run Touch pad/PS2 Mode Driver.
2. Run utility with the PS/2 mouse function and check if the mouse is working.
3. If the PS/2 mouse does not work, then check if the main board to switch board FPC is connected well.
4. If the main board to switch board FPC is connected well, then check if the touch pad FPC connects to the main board properly.
5. If there is still an error after you have connected the touch pad FPC to the main board properly, then replace the touch pad or touch pad FPC. The touch pad or touch pad FPC may be damaged.
6. Replace switch board.
7. If the touch pad still does not work, then replace the FPC on Track Pad PCB.

After you use the touchpad, the pointer drifts on the screen for a short time. This self-acting pointer movement can occur when a slight, steady pressure is applied to the touchpad pointer. This symptom is not a hardware problem. No service actions are necessary if the pointer movement stops in a short period of time.

## Display Check

1. Connect an external display to the computer's external monitor port, the boot the computer. The computer can automatically detect the external display. Press Fn+  $\square$  to switch to the external display.
2. If the external display works fine, the internal LCD may be damaged. Then perform the following steps:

Make sure the DDRRAM module is seated properly. Then run the display test again. If the problem still exists, go to next step.

Replace the inverter board, then run the display test program again. If the problem still occurs, go on next step.

Replace the LCD module with a new one then run the display test again. If the problem still happens, continue next step.

Replace LCD/FL cable with a new one then execute the display diagnostic again. If the problem



---

still occurs, continue next step.

Replace the CPU with another of the same specifications. If the problems still occurs, go to next step.

The main board may be damaged. Replace main board.

3. If the external monitor has the same problem as the internal monitor, the main board may be damaged. Please insert the diagnostic disk and run the display test program and go through the sub-steps under step 2.

## Sound Check

To determine if the computer's built-in speakers are functioning properly, perform the following steps. Before you start the steps below, adjust the speaker volume to an appropriate level.

1. Try different audio sources. For example, employ audio CD and digital music file to determine whether the fault is in the speaker system or not. If not all sources have sound problem, the problem is in the source devices. If all have the same problem, continue next step.
2. Connect a set of earphone or external speakers. If these devices work fine, go to next step. If not, then the main board may be defective or damaged. Replace the main board.
3. Follow the disassembling steps in Chapter 3. Ensure the speaker cable is firmly connected to the main board. If the speaker is still a malfunction, go on next step.
4. If the speakers do not sound properly, the speakers may be defective or damaged. Replace the speakers. If the problem still occurs, then replace the main board.

## Insyde MobilePro BIOS POST Beep Code and POST Messages

The POST error message index lists the error message and their possible causes. The most likely cause is listed first.

**NOTE:** Perform the FRU replacement or actions in the sequence shown in FRU/Action column, if the FRU replacement does not solve the problem, put the original part back in the computer. Do not replace a non-defective FRU.

This index can also help you determine the next possible FRU to be replaced when servicing a computer.

If the symptom is not listed, see “Undetermined Problems” on page 73.

The following lists the error messages that the BIOS displays on the screen and the error symptoms classified by function.

**NOTE:** Most of the error messages occur during POST. Some of them display information about a hardware device, e.g., the amount of memory installed. Others may indicate a problem with a device, such as the way it has been configured.

**NOTE:** If the system fails after you make changes in the BIOS Setup Utility menus, reset the computer, enter Setup and install Setup defaults or correct the error.

Beep Code	Message	Description
short, short, short; short, short, long	“FAULTY DMA PAGE REGISTERS”	DMA page registers do not function properly.
short, short, short; short, long, short	“FAULTY REFRESH CIRCUIT”	RAM refresh circuit does not function properly.
short, short, short; short, long, long	“ROM CHECKSUM INCORRECT”	BIOS ROM checksum failed.
short, short, short; long, short, short	“CMOS RAM TEST FAILED”	CMOS RAM test failed.
short, short, short; long, short, long	“DMA CONTROLLER FAULTY”	DMA controller does not work properly.
short, short, short; long, long short	“INTERRUPT CONTROLLER FAILED”	The interrupt controller does not work properly.
short, short, short; long, long, long	N/A	Keyboard controller failed to respond with the self-test command.
short, short, long; short, short, short	N/A	No video device found.
short, short, long; short, short, long	N/A	No RAM installed.
N/A	“KEYBOARD CONTROLLER FAILURE”	Keyboard controller failed during system inquiry about connected devices.
N/A	“KEYBOARD FAILURE”	The keyboard fails to respond or no keyboard is connected.
N/A	“CMOS FAILURE - RUN SCU”	CMOS data error, probably due to battery power loss.
N/A	“CMOS CHECKSUM INVALID - RUN SCU”	CMOS checksum error.
N/A	“RAM ERROR AT LOCATION xxxxxx: WROTE: xxxx READ: xxxx”	The RAM failed during memory test at the indicated location.

Beep Code	Message	Description
N/A	"PARITY ERROR AT UNKNOWN LOCATION"	Parity error during memory test at unknown location.
N/A	"PARITY ERROR AT LOCATION XXXXXX"	Parity error during memory test at the indicated location.
N/A	"NO INTERRUPTS FROM TIMER 0"	Timer 0 of the clock timer controller does not generate system interrupts correctly.
N/A	"UNEXPECTED AMOUNT OF MEMORY - RUN SCU"	The system memory size does not match with the CMOS record.
N/A	"CLOCK NOT TICKING CORRECTLY"	The system clock does not working correctly.
N/A	"TIME/DATA CORRUPT - RUN SCU"	The time/date information in CMOS is invalid.
N/A	"MACHINE IS LOCKED - TURN KEY"	The keyboard operation is locked.
N/A	"BOOT SECTOR 0 HAS CHANGED"	The boot sector of the hard disk has been changed, probably because of a virus attack.
N/A	Suspend-to-Disk partition MISSING!"	No Suspend-to-Disk partition found.
N/A	"Hard Disk ERROR!"	Access to the Suspend-to-Disk partition failed.
N/A	"Suspend-to-Disk partition signature NOT FOUND!"	No Suspend-to-Disk partition signature found.
N/A	"Suspend-to-Disk partition size TOO SMALL!"	The capacity of the Suspend-to-Disk partition is not enough.
N/A	"MEMORY SIZE HAS CHANGED -- REBOOTING"	The memory size has changed after previous Suspend-to-Disk operation.

# Index of Symptom-to-FRU Error Message

## LCD-Related Symptoms

Symptom / Error	Action in Sequence
LCD backlight doesn't work LCD is too dark LCD brightness cannot be adjusted LCD contrast cannot be adjusted	Enter BIOS Utility to execute "Load Setup Defaults" on Exit screen, then reboot system. Reconnect the LCD connectors. Keyboard (if contrast and brightness function key doesn't work). LCD cable LCD inverter LCD Main board
Unreadable LCD screen Missing pels in characters Abnormal screen Wrong color displayed	Reconnect the LCD connector LCD cable LCD inverter LCD Main board
LCD has extra horizontal or vertical lines displayed.	LCD inverter LCD cable LCD Main board

## Indicator-Related Symptoms

Symptom / Error	Action in Sequence
Indicator incorrectly remains off or on, but system runs correctly	Reconnect the inverter board Inverter board Main board

## Power-Related Symptoms

Symptom / Error	Action in Sequence
Power shuts down during operation	Power source (battery pack and power adapter). See "Power System Check" . Battery pack Power adapter Hard drive & battery connection board Main board
The system doesn't power-on.	Power source (battery pack and power adapter). See "Power System Check" . Battery pack Power adapter Hard drive & battery connection board Main board
The system doesn't power-off.	Power source (battery pack and power adapter). See "Power System Check" . Hold and press the power switch for more than 4 seconds. Main board
Battery can't be charged	See "Check the Power Adapter". Battery pack Main board

### PCMCIA-Related Symptoms

Symptom / Error	Action in Sequence
System cannot detect the PC Card (PCMCIA)	PCMCIA slot assembly Main board
PCMCIA slot pin is damaged.	PCMCIA slot assembly

### Memory-Related Symptoms

Symptom / Error	Action in Sequence
Memory count (size) appears different from actual size.	DIMM Main board

### Speaker-Related Symptoms

Symptom / Error	Action in Sequence
In Windows, multimedia programs, no sound comes from the computer.	See "Sound Check" on page 66 Audio driver Speaker Main board
Internal speakers make noise or emit no sound.	See "Sound Check" on page 66 Speaker Main board

### Power Management-Related Symptoms

Symptom / Error	Action in Sequence
The system will not enter hibernation	Keyboard (if control is from the keyboard) Hard disk drive Main board
The system doesn't enter hibernation mode and four short beeps every minute.	Press Fn+F4 and see if the computer enters hibernation mode. Touchpad Keyboard Hard disk connection board Hard disk drive Main board
The system doesn't enter standby mode after closing the LCD	LCD cover switch Main board
The system doesn't resume from hibernation mode.	Hard disk connection board Hard disk drive Main board
The system doesn't resume from standby mode after opening the LCD.	LCD cover switch Main board
Battery fuel gauge in Windows doesn't go higher than 90%.	Remove battery pack and let it cool for 2 hours. Refresh battery (continue use battery until power off, then charge battery). Battery pack Main board

### Power Management-Related Symptoms

Symptom / Error	Action in Sequence
System hangs intermittently.	Reconnect hard disk drives. Hard disk drive connector Main board

### Peripheral-Related Symptoms

Symptom / Error	Action in Sequence
System configuration does not match the installed devices.	Enter BIOS Setup Utility to execute "Load Setup defaults", then reboot system. Reconnect hard disk/CD-ROM/diskette drives.
External display does not work correctly.	See if there is an error beep. If there is an error beep, then change main board. Power off. Then check if RAM CPU BIOS are well-connected. Press Fn+F5 three times slowly LCD FPC LCD inverter LCD
USB does not work correctly	USB device cable is firmly connected into the USB ports. Test one USB port each time. USB socket is firmly secured to the main board. Main board
Print problems.	Ensure the "Parallel Port" in the "System Devices" of BIOS Setup Utility is set to Enabled. Onboard Devices Configuration Run parallel port test Printer driver Printer cable Printer Main board

### Keyboard/Touchpad-Related Symptoms

Symptom / Error	Action in Sequence
Keyboard (one or more keys) does not work.	Reconnect the keyboard cable. Keyboard Main board
Touchpad does not work.	Reconnect touch pad cable. Modem port is secured to the main board Touch pad FPC Audio/Touch pad board Main board

---

### Modem-Related Symptoms

Symptom / Error	Action in Sequence
Internal modem does not work correctly.	Ensure the telephone cable is firmly plugged into the telephone wall socket and the modem port of the computer. Modem phone port is secured to the main board. modem combo board Main board

---

## Intermittent Problems

Intermittent system hang problems can be caused by a variety of reasons that have nothing to do with a hardware defect, such as: cosmic radiation, electrostatic discharge, or software errors. FRU replacement should be considered only when a recurring problem exists.

When analyzing an intermittent problem, do the following:

1. Run the diagnostic test for several times to isolate the problem.
2. If no error is detected, do not replace any FRU.
3. If any error is detected, replace the FRU. Rerun the test to verify that there are no more errors.



---

## Undetermined Problems

The diagnostic problems does not identify which adapter or device failed, which installed devices are incorrect, whether a short circuit is suspected, or whether the system is inoperative.

Follow these procedures to isolate the failing FRU (do not isolate non-defective FRU).

**NOTE:** Verify that all attached devices are supported by the computer.

1. Power-off the computer.
2. Visually check them for damage. If any problems are found, replace the FRU.
3. Remove or disconnect all of the following devices:
  - Non-Acer devices
  - Printer, mouse, and other external devices
  - Battery pack
  - Hard disk drive
  - DIMM
  - CD-ROM/Diskette drive Module
  - PC Cards
4. Power-on the computer.
5. Determine if the problem has changed.
6. If the problem does not recur, reconnect the removed devices one at a time until you find the failing FRU.
7. If the problem remains, replace the following FRU one at a time. Do not replace a non-defective FRU:
  - Main board
  - LCD assembly

## Jumper and Connector Locations

### Top View

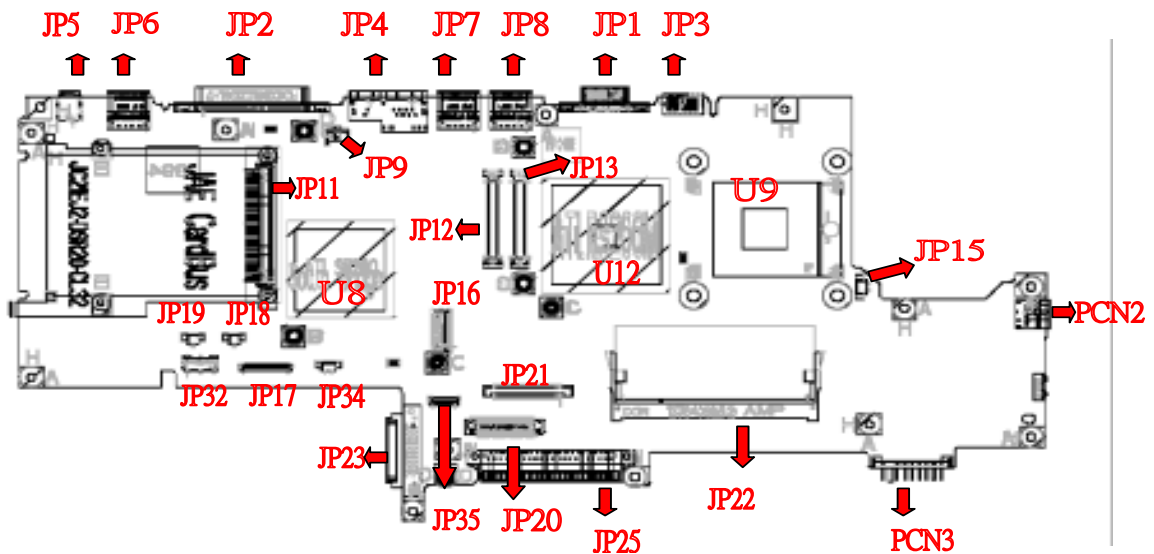

Item	Description
JP1	CRT
JP2	Parallel Port
JP3	TV-Out Connector
JP4	RJ11/45 Connector
JP5	1394 Connector
JP6/7/8	USB Connector
JP9	Modem Connector
JP11	PCMCIA Connector
JP12/13	AGP Connector
JP15	FAN Connector
JP16	MDC Connector
JP17	System Connector
JP18	R-SPK Connector
JP19	L-SPK Connector
JP20	T/P Connector
JP21	KB Connector
JP22	SO-DIMM1 Connector
JP23	CD-ROM Connector
JP25	HDD Connector
JP32	Cardreader Connector

---

Item	Description
JP34	Subwoofer Connector
JP35	Bluetooth Connector
U9	CPU
U12	North Bridge
U8	South Bridge
PCN2	AC Jack
PCN3	Battery Connector

## Bottom View

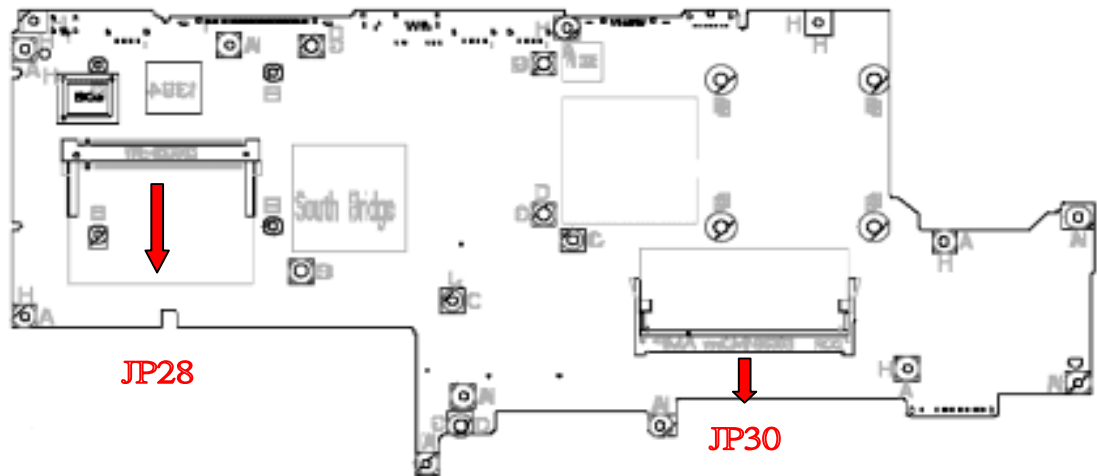

Item	Description
JP28	Mini-PCI Connector
JP30	SO-DIMM0 Connector

# FRU (Field Replaceable Unit) List

---

This chapter gives you the FRU (Field Replaceable Unit) listing in global configurations of Aspire 2000. Refer to this chapter whenever ordering for parts to repair or for RMA (Return Merchandise Authorization). Please also note that there are some common parts for Aspire 2000, yet the LCD modules are different in two model.

Please note that WHEN ORDERING FRU PARTS, you should check the most up-to-date information available on your regional web or channel. For whatever reasons a part number change is made, it will not be noted on the printed Service Guide. For ACER AUTHORIZED SERVICE PROVIDERS, your Acer office may have a DIFFERENT part number code from those given in the FRU list of this printed Service Guide. You MUST use the local FRU list provided by your regional Acer office to order FRU parts for repair and service of customer machines.

**NOTE:** To scrap or to return the defective parts, you should follow the local government ordinance or regulations on how to dispose it properly, or follow the rules set by your regional Acer office on how to return it.

# Exploded Diagram

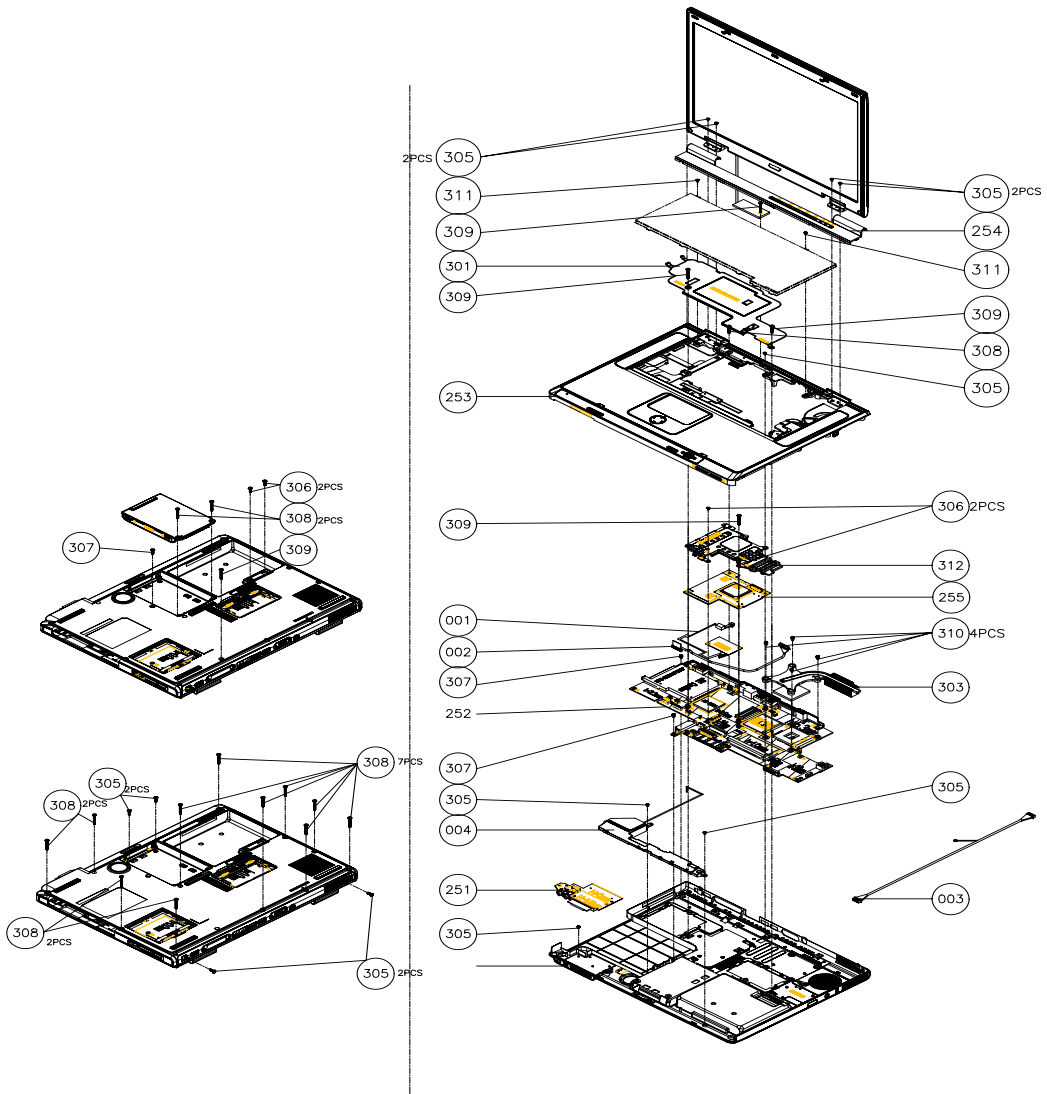

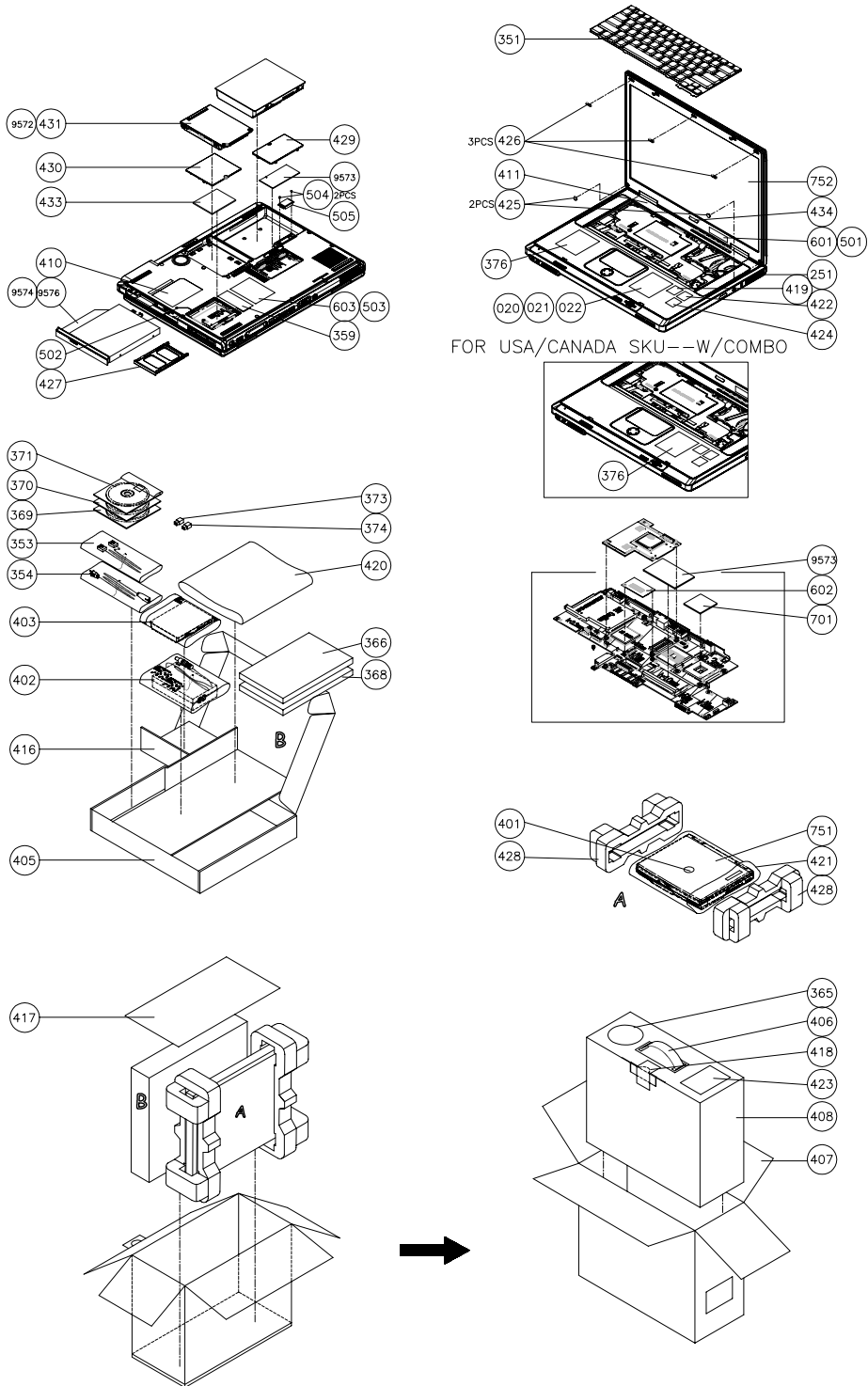

Picture	No.	Part Name/ Description	Part Number
ADAPTER			
N/A		ADAPTER W/LED -DELTA 65W ADP-65B ADAPTER W/O LED - LITEON 65W PA-1650-02CR	AP.A1401.001 AP.T3503.001
BATTERY			
		BATTERY LI-ION 12 CELLS-PANASONIC GC86503PAJ0 BATTERY LI-ION 12 CELLS-SAMSUNG GC86508SMG0	BT.A1405.001 BT.A1401.001
BOARDS			
		MODEM BOARD AMBIT T60M283	54.A14V5.001
		MINI PCI WIRELESS BOARD (802.11b) INTEL	54.A14V5.002
N/A		MINI PCI WIRELESS BOARD (802.11a+b) INTEL	54.A14V5.003
		LAUNCH BOARD	55.A14V5.002
N/A		WIRELESS & B/T SWITCH BOARD	55.A14V5.003
		VGA BOARD	55.A14V5.004
		LCM BOARD	55.A14V5.005







Picture	No.	Part Name/ Description	Part Number
		LCD INVERTER	19.A14V5.001
<b>CABLES</b>			
		CARD READER WIRE SET	50.A14V5.001
		LAUNCH BOARD CABLE	50.A14V5.002
		MODEM CABLE	50.A14V.003
		TOUCHPAD FFC CABLE	50.A14V5.004
		BLUETOOTH CABLE	50.A14V5.005
		LCD COAXIAL CABLE-15.4" WXGA	50.A14V5.007
		LCD COAXIAL CABLE-15.4" WSXGA	50.A14V5.008
N/A		POWER CORD US	27.A14V5.001
		POWER CORD EC	27.A14V5.002
		POWER CORD AUS	27.A14V5.003
		POWER CORD UK	27.A14V5.004
		POWER CORD SWISS	27.A14V5.005
		POWER CORD CHINA	27.A14V5.006
		POWER CORD ITALIAN	27.A14V5.007
		POWER CORD DENMARK	27.A14V5.008





Picture	No.	Part Name/ Description	Part Number
COVER/CASE/BACKET ASSEMBLY			
		MIDDLE COVER	42.A14V5.001
		LOWER COVER	60.A14V5.001
N/A		DIMM COVER	42.A14V5.002
		UPPER CASE ASSY	60.A14V5.002
		MINI PCI COVER	42.A14V5.003
		TOUCHPAD BRACKET W/FPC	33.A14V5.001
		K/B SUPPORT PLATE	33.A14V5.002
		VGA BRACKET	33.A14V5.003
		LCD PANEL WITH LOGO	60.A14V5.003

Picture	No.	Part Name/ Description	Part Number
		LCD BEZEL	42.A14V5.008
		LCD BRACKET L	33.A14V5.006
		LCD BRACKET R	33.A14V5.007
N/A		PCMCIA SLOT	22.A14V5.001
<b>COMMUNICATION MODULE</b>			
		ANTENNA ASSY	50.A14V5.006
<b>CPU/PROCESSOR</b>			
N/A		INTEL PENTIUM-M(BANIAS)1.4GHZ 1M/400MHZ FSB	KC.BS001.14G
		INTEL PENTIUM-M(BANIAS)1.5GHZ 1M/400MHZ FSB	KC.BS001.15G
		INTEL PENTIUM-M(BANIAS)1.6GHZ 1M/400MHZ FSB	KC.BS001.16G
		INTEL PENTIUM-M(BANIAS)1.7GHZ 1M/400MHZ FSB	KC.BS001.17G
		INTEL PENTIUM-M(BANIAS)1.8GHZ 1M/400MHZ FSB	KC.BS001.18G
<b>DVD/CDRW DRIVE</b>			
N/A		DVD/CDRW COMBO MODULE HLDS (SLOT IN)(GCC4241N)	6M.A14V5.001
		DVD/CDRW COMBO DRIVE HLDS (SLOT IN)(GCC4241N)	KO.02406.003

Picture	No.	Part Name/ Description	Part Number
		DVD/CDRW COMBO BEZEL FOR HLDS(TRAY)	42.A14V5.004
		OPTICAL DEVICE BRACKET	33.A14V5.004
<b>HDD/HARD DISK DRIVE</b>			
N/A		HDD 2.5" HGST MORAGA IC25N030ATMR04-0 08K0910 30G 4200RPM	KH.03007.002
		HDD 2.5" HGST MORAGA IC25N040ATMR04-0 08K0633 30G 4200RPM	KH.04007.004
		HDD 2.5" HGST MORAGA IC25N060ATMR04-0 08K0634 60G 4200RPM	KH.06007.002
		HDD 2.5" HGST MORAGA IC25N080ATCS04-0 08K0635 80G 4200RPM	KH.08007.002
		HDD 2.5" HGST MORAGA HTS548060M9AT00 08K0638 60G 5400RPM	KH.06007.003
		HDD 2.5" HGST MORAGA HTS548080M9AT00 08K0638 60G 5400RPM	KH.08007.003
		HDD 2.5" TOSHIBA NEPTUNE MK3021GAS 30GB 4200RPM	KH.33004.001
		HDD 2.5" TOSHIBA NEPTUNE MK4021GAS 40GB 4200RPM	KH.34004.001
		HDD 2.5" TOSHIBA NEPTUNE MK6021GAS 60GB 4200RPM	KH.36004.001
		HDD 2.5" FUJITSU V-40 MHT2030AT 30G 4200RPM	KH.03006.002
		HDD 2.5" FUJITSU V-40 MHT2040AT 40G 4200RPM	KH.04006.002
		HDD 2.5" FUJITSU V-40 MHT2060AT 60G 4200RPM	KH.06006.002
		HDD CARRIER	42.A14V5.007

Picture	No.	Part Name/ Description	Part Number
		HDD TOP COVER	33.A14V5.005
		HDD CONNECTOR	20.A14V5.001
<b>KEYBOARD</b>			
		KEYBOARD ARABIC KEYBOARD BELGIUM KEYBOARD CHINESE KEYBOARD CZECH KEYBOARD DANISH KEYBOARD FRENCH KEYBOARD GERMAN KEYBOARD ITALIAN KEYBOARD NORWEGIAN KEYBOARD PORTUGUESE KEYBOARD SPANISH KEYBOARD SWEDEN KEYBOARD SWISS/G KEYBOARD THAI KEYBOARD UK KEYBOARD US INTERNATIONAL KEYBOARD HUNGARIAN KEYBOARD CANADIAN FRENCH KEYBOARD RUSSIAN	KB.A1402.011 KB.A1402.013 KB.A1402.005 KB.A1402.015 KB.A1402.018 KB.A1402.006 KB.A1402.003 KB.A1402.004 KB.A1402.017 KB.A1402.010 KB.A1402.009 KB.A1402.014 KB.A1402.008 KB.A1402.012 KB.A1402.002 KB.A1402.001 KB.A1402.016 KB.A1402.007 KB.A1402.019
<b>LCD MODULE</b>			
		ASSY LCD MODULE 15.4" WXGA SAMSUNG (LTN154I1-L02) ASSY LCD MODULE 15.4" WXGA CMO (LTN154X1-L02) ASSY LCD MODULE 15.4" WXGA LG (LTN154W01-A3) ASSY LCD MODULE 15.4" WXGA CPT (CLAA154WA01) ASSY LCD MODULE 15.4" WSXGA LG (LP154W02-A1) ASSY LCD MODULE 15.4" WSXGA SAMSUNG (LTN154P1-L02)	6M.A14V5.004 6M.A14V5.005 6M.A14V5.006 6M.A14V5.007 6M.A14V5.008 6M.A14V5.009
<b>LCD</b>			

Picture	No.	Part Name/ Description	Part Number
		LCD 15.4" WXGA SAMSUNG (LTN154I1-L02)	LK.15406.001
		LCD 15.4" WXGA CMO (LTN154X1-L02)	LK.1540D.001
		LCD 15.4" WXGA LG (LP154W01-A3)	LK.15408.001
		LCD 15.4" WXGA CPT (CLAA154WA01)	LK.1540A.001
		LCD 15.4" WSXGA LG (LP154W02-A1)	LK.15408.002
		LCD 15.4" WSXGA SAMSUNG (LTN154P1-L02)	LK.15406.002
	<b>MAINBOARD</b>		
		MAINBOARD W/PCMCIA SLOT, W/O CPU, MEMORY	MB.A1402.001
<b>MEMORY</b>			
N/A		256MB DDR333 HYS64D32020GDL-6-B INFINEON	KN.25602.009
		256MB DDR333 HYS64D64020GBDL-6-B INFINEON	KN.51202.007
		256MB DDR333 MT8VDDT3264HDG- 335C3 MICRON	KN.25604.009
		512MB DDR333 MT16VDDS6464HDG- 335C3 MICRON	KN.51204.006
		256MB DDR333 NT256D64SH8BAGM-6K NANYA	KN.25603.009
		512MB DDR333 NT512D64S8HBAFM-6K NANYA	KN.51203.005
<b>FAN</b>			
		FAN	23.A14V5.001
<b>HEATSINK</b>			
		THERMAL MODULE	60.A14V5.004

Picture	No.	Part Name/ Description	Part Number
<b>POINTING DEVICE</b>			
		TOUCHPAD	56.A14V5.001
<b>READER</b>			
		4 IN 1 CARD READER BOARD	55.A14V5.006
<b>SPEAKER</b>			
		SPEAKER SET (R&L) - VECO	6K.A14V5.001
		SUB-WOOFER-FORTUNE	23.A14V5.002
<b>MISCELLANEOUS</b>			
N/A		LCD RUBBER	47.A14V5.001
		LCD SCREW PAD	47.A14V5.002
		RUBBER FOOT	47.A14V5.003
<b>SCREW LIST</b>			
N/A		SCREW,JIM M2.0X4	86.A14V5.001
		SCREW,JIM M2.5X4	86.A14V5.002
		SCREW,JIM M2.5X5	86.A14V5.003
		SCREW,JIM M2.5X10	86.A14V5.004
		SCREW,JIM M2.5X14	86.A14V5.005
		SCREW,JIM M3.0X3	86.A14V5.006
		SCREW,JPM M2.0X8 (Ni)	86.A14V5.007
		SCREW,JPM M2.0X6 (Ni)	86.A14V5.008
		SCREW,JACK SCREW	86.A14V5.009
		SCREW,M2.5X5	86.A14V5.010
		SCREW,SPECIAL SCREW	86.A14V5.011

# Model Definition and Configuration

## Aspire 2000 series

Model Number	CPU	LCD	Memory	HDD	Optical	Card Reader	Mini PCI	Battery
AS2001WLCi	PM1.4G	15.4 WXGA	1x256M/ 2x256M	40G/ 60G (4200rpm)	24X DVD+C D-RW	4 in 1	11b	Li-ion
AS2001WLMi	PM1.4G	15.4 WXGA	1x256M	40G	2X DVD-RW	4 in 1	11b	Li-ion
AS2003WLMi	PM1.6G	15.4 WXGA	2x256M	60G	2X DVD+C D-RW	4 in 1	11b	Li-ion
2001WLCi	PM1.4G	15.4 WXGA	1x256M 2x256M	40G	24X DVD+C D-RW	4 in 1	11b	Li-ion
2001WLMi	PM1.4G	15.4 WXGA	2x256M	40G/ 60G (4200rpm)	2X DVD-RW	4 in 1	11b	Li-ion
2002WLCi	PM1.5G	15.4 WXGA	2x256M	40G	24X DVD+C D-RW	4 in 1	11b	Li-ion
2002WLMi	PM1.5G	15.4 WXGA	2x256M	60G (4200rpm)	2X DVD-RW	4 in 1	11b	Li-ion
2003WLMi	PM1.6G	15.4 WXGA	2x256M	60G (4200rpm)	2X DVD-RW	4 in 1	11b	Li-ion



# Test Compatible Components

---

This computer's compatibility is tested and verified by Acer's internal testing department. All of its system functions are tested under Windows XP Home environment.

Refer to the following lists for components, adapter cards, and peripherals which have passed these tests.

Regarding configuration, combination and test procedures, please refer to the Aspire 2000 Compatibility Test. Report released by the Acer Mobile System Testing Department.

# Microsoft Windows XP (Home) Environment Test

Component	Manufacturer	Specifications
Banias 1.4 GHz	Intel	400 MHz FSB RH80535GC0171M
Banias 1.5 GHz		400 MHz FSB RH80535GC0211M
Banias 1.6 GHz		400 MHz FSB RH80535GC0251M
Banias 1.7GHz		400 MHz FSB RH80535GC0291M
256MB DDR-333	Infineon Micro	HYS64D32020GDL-6-B MT8VDDT3264HDG-335C3(13u)
512MB DDR-333	Micro Infineon	MT16VDDF6464HG-335C2(13u) HYS64D64020GBDL-6-B
ATI VRAM	Hynix Infineon Samsung	4M32AF-3.6/550 4M32-3.3/600 4M32E-3.6/550
15.4" WXGA TFT	Samsung LG CMO	LTN154X1-L02 LP154W01-A3 N154I1-L02
15.4" WSXGA+TFT	LG	LP154W02-A1
15.4" WXGA LCD CABLE	Hannstar Hightek Wanshih	
15.4" WSXGA +LCD CABLE	Hannstar Hightek Wanshih	
86-Key Keyboard	Zippy Jing Mold	
Inverter	Ambit Sumida	COMMON T51I056.03 COMMON TWS-442-132
Trackpad	Synaptics	TM42puf1372
30GB HDD ATA-100 (4200RPM)	HGST Toshiba	IC25N030ATMR04-A MK3021 GAS
40GB HDD ATA-100 (4200RPM)	HGST	IC25N040ATMR04-0
60GB HDD ATA-100 (4200RPM)	HGST Toshiba	IC25N060ATMR04-0 MK6021GAS
80GB HDD ATA-100 (4200RPM)	HGST Toshiba	IC25N080ATMR04-0 MK8021GAS
60GB HDD ATA-100(5400RPM)	HGST	HTS548060M9AT00
80GB HDD ATA-100(5400RPM)	HGST	HTS548080M9AT00
DVD/RW (COMBO)	Panasonic(slot-in) HLDS (Tray)	CW-8122 (HW/FW) GCC-4241N (HW/FW)
DVD/Multi	Panasonic (slot-in)	UJ-815 (HW/FW)
8-Cell Li-Ion	Samsung(2200) Panasonic(2200)	ICR18650-22 CGR18650C
802.11b/a+b Antenna	WNC WNC	81.EBF15.001 81.EBF15.002

---

Component	Manufacturer	Specifications
802.11b (Mini-PCI)	Intel Centrion	WM3B2100NA_MOW
Modem(MDC)	Ambit	T60M283
Windows XP Home	Microsoft	w/SP1
Windows XP Pro	Microsoft	w/SP1
Slimline 65W AC Adapter	LITEON Delta	PA-1650-02CR ADP-65B

# Online Support Information

---

This section describes online technical support services available to help you repair your Acer Systems. If you are a distributor, dealer, ASP or TPM, please refer your technical queries to your local Acer branch office. Acer Branch Offices and Regional Business Units may access our website. However some information sources will require a user i.d. and password. These can be obtained directly from Acer CSD Taiwan.

Acer's Website offers you convenient and valuable support resources whenever you need them.

In the Technical Information section you can download information on all of Acer's Notebook, Desktop and Server models including:

- Service guides for all models
- User's manuals
- Training materials
- Bios updates
- Software utilities
- Spare parts lists
- TABs (Technical Announcement Bulletin)

For these purposes, we have included an Acrobat File to facilitate the problem-free downloading of our technical material.

Also contained on this website are:

- Detailed information on Acer's International Traveler's Warranty (ITW)
- An overview of all the support services we offer, accompanied by a list of telephone, fax and email contacts for all your technical queries.

We are always looking for ways to optimize and improve our services, so if you have any suggestions or comments, please do not hesitate to communicate these to us.

